

## Luminaires characteristics

MODELS	POWER (W/ft)	OPTIC	LUMEN (lm/ft)	EFFICACY (lm/W)	MAX CANDELA (cd)
RGBW	4.5W/ft	SP 10°x10°	260	65	1 403
		WGS 14°x14°	214	53	728
		WGM 23°x41°	197	49	379
		WGWF 27°x59°	180	45	277
		ELL 22°x60°	226	56	401
RGBW NO DOT	5W/ft	GL NO DOT	112	24	97
		WG NO DOT	87	17	104
TUNABLE WHITE 2200K-3000K	3.9W/ft	WGS 14°x14°	270	71	1 015
		WGM 23°x41°	259	68	505
		WGWF 27°x59°	238	62	377
TUNABLE WHITE 2700K-4000K	3.9W/ft	WGS 14°x14°	290	76	1 091
		WGM 23°x41°	279	73	543
		WGWF 27°x59°	256	67	405

## Source:

RGBW, white LED: 3000K, 80CRI  
 RGBW, white LED: 3500K, 80CRI  
 Tunable white 2200K to 3000K, 80 CRI  
 Tunable white 2700K to 4000K, 80 CRI

## Lumen maintenance:

For RGBW: 80% of initial lumens at 100 000 hours (L80 B10) Ta 77°F and 104°F (25°C and 40°C) (LM-80)  
 For Tunable white: 85% of initial lumens at 100 000 hours (L85 B10) Ta 77°F and 104°F (25°C and 40°C) (LM-80)

## Optic:

**Symmetrical optics:** Spot or general light.  
**Wall grazer optics:** Spot, medium, wide flood or no dot.  
**Elliptical optic:** 22°x60°

## Material:

Body: Extruded aluminum.  
 End caps: Die-cast aluminum with silicone seals.  
 Protective screen: 1/4" (5mm) transparent glass.  
 Hardware: Stainless steel.

## Mounting:

Ceiling, floor or wall mounted with fix-flat or arm accessories. Ground installation with arms on spike.

## Electrical:

24Vdc remote LED driver. See remote option page 4.

## Dimming:

DMX RDM (120-277V) or DALI (120-277) down to 0.1%. See dimming options page 4.

## Temperature of operation:

-22°F to 122°F (-30°C to 50°C)

## Glass surface temperature:

104°F (40°C) maximum.

## Finish:

Black, gray (RAL9007), rust brown or white (RAL9016), with a high level of weather and UV resistance. The semi-gloss finish coating is electrostatically applied, durable acrylic enamel baked at high temperatures for superior color retentive finish.

## Weight:

0.99lb/ft (0.45kg/ft)

## Warranty:

5 year limited warranty.

## Ratings:

IP66, IK06

## Certification:



cULus for wet location.

## ORDERING INFO



PRODUCT CODE

MODEL	LENGTH <sup>1</sup>	OUTPUT	LED	OPTIC	MOUNTING	ARM	REM	FINISH	EXTERNAL OPTIONAL ACCESSORIES <sup>4</sup>																																			
<b>ILL27S</b> Linealuce 27 Surface	<b>01</b> 1.08' (329mm)	<b>BO</b> Base output	<b>RGBW830</b> RGB White 3000K, 80CRI	<b>SYMMETRICAL</b>  <b>SP</b> <sup>5</sup> Spot 10°x10°  <b>GL</b> General light, No dot 45°x82°	<b>S</b> <sup>2</sup> Surface Flat installation no arm	<b>1</b> <sup>2</sup> No arm	<b>REM</b> Remote	<b>01</b> White	<b>A1</b> Satin screen																																			
	<b>02</b> 2.05' (625mm)									<b>RGBW835</b> RGB White 3500K, 80CRI	<b>GRAZER</b>	<b>M</b> Arm installation for height below 9.5' (3m)	<b>2</b> Black short adjustable 1-5/8" (41mm)	<b>02</b> Black	<b>A2</b> Visor																													
	<b>03</b> 3.02' (920mm)															<b>TW82230</b> <sup>7</sup> Tunable White 2200K to 3000K, 80CRI	<b>WGS</b> Spot 14°x14°	<b>U</b> Arm installation for height greater than 9.5' (3m)	<b>3</b> Steel short adjustable 1-5/8" (41mm)	<b>15</b> Gray	<b>A3</b> Transversal louver																							
	<b>04</b> 3.99' (1216mm)																					<b>TW82740</b> <sup>7</sup> Tunable White 2700K to 4000K, 80CRI	<b>WGM</b> Medium 23°x41°	<b>G</b> Ground Spike in soil with arm	<b>4</b> Black adjustable arms 2-3/4" (71mm)	<b>F5</b> Rust brown	<b>A4</b> Longitudinal louver																	
	<b>05</b> 4.96' (1511mm)																											<b>WGWF</b> Wide flood 27°x59°	<b>5</b> Steel adjustable arms 2-3/4" (71mm)	<b>6</b> Black adjustable arms 4-3/4" (121mm)	<b>A5</b> Honeycomb louver													
	<b>06</b> 6.04' (1842mm)																															<b>WG</b> No dot 21°x80°	<b>7</b> Steel adjustable arms 4-3/4" (121mm)	<b>8</b> Black adjustable arms 8-3/4" (221mm)	<b>A6</b> Visor + transversal louver									
	<b>07</b> 7.01' (2138mm)																																			<b>ELLIPTICAL</b>	<b>8</b> Black adjustable arms 8-3/4" (221mm)	<b>9</b> Steel adjustable arms 8-3/4" (221mm)	<b>A7</b> Linear prismatic screen					
	<b>08</b> 7.99' (2434mm)																																							<b>ELL</b> <sup>5</sup> Elliptical 22°x60°	<b>10</b> <sup>3</sup> Black single adjustable arm 4-3/4" (121mm) <b>for 1ft module only</b>	<b>A8</b> Protective frame (For IK10)		
	<b>09</b> 8.95' (2729mm)																																										<b>11</b> <sup>3</sup> Stainless steel single adjustable arm 4-3/4" (121mm) <b>for 1ft module only</b>	
	<b>10</b> 9.92' (3024mm)																																											
	<b>11</b> <sup>6</sup> 11.01' (3355mm)																																											
	<b>12</b> <sup>6</sup> 11.98' (3651mm)																																											
	<b>13</b> <sup>6</sup> 12.95' (3946mm)																																											
	<b>14</b> <sup>6</sup> 13.91' (4242mm)																																											
	<b>15</b> <sup>6</sup> 14.89' (4537mm)																																											
	<b>16</b> <sup>6</sup> 15.98' (4868mm)																																											
	<b>17</b> <sup>6</sup> 16.94' (5164mm)																																											
	<b>18</b> <sup>6</sup> 17.91' (5459mm)																																											
	<b>19</b> <sup>6</sup> 18.88' (5755mm)																																											
	<b>20</b> <sup>6</sup> 19.84' (6050mm)																																											

(1) Length 6ft and more are module composition in continuous row. See page 9 for module details.

(2) For Surface flat without arm mounting only (S1)

(3) Available for mounting G, 1ft module only

(4) Consult page 3 or Instruction sheet to see optic/accessory recommendation

(5) Optics not recommended for wall lighting

(6) For 3.9W/ft max length per feed is 20ft, for 4.5W/ft max length per feed is 13ft and for 5W/ft max length per feed is 11ft.

(7) Available with wall grazer spot, medium and wide flood optics only (WGS, WGM, WGWF).

## INCLUDED IN PRODUCT CODE

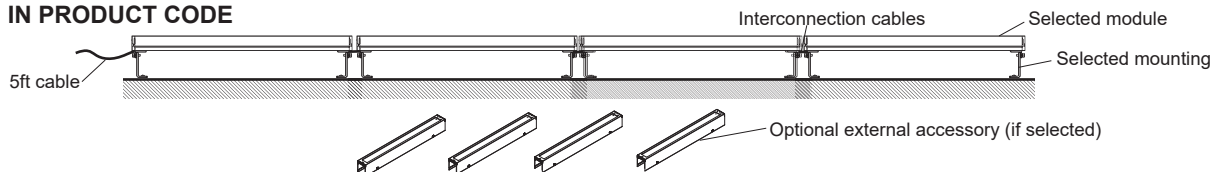

**ACCESSORIES**

Consult instruction sheet for limitations and detail on installation.  
 All optical accessories must be assemble to the product before installation.

**A1- Satin screen**

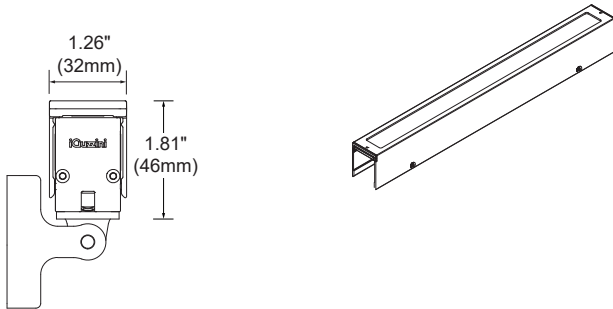

**A2- Visor**

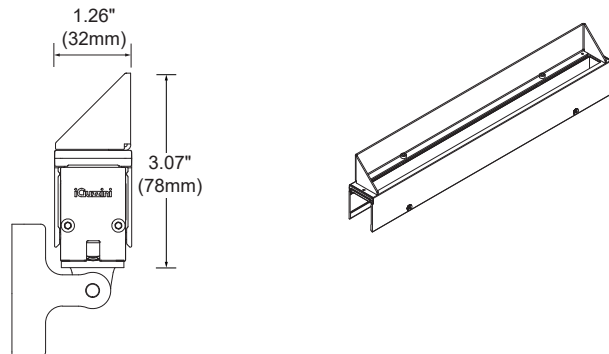

**A3- Transversal louver**

Not recommended for all wall grazer optics.

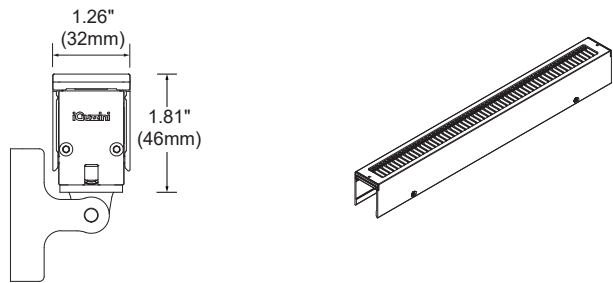

**A4- Longitudinal louver**

Not recommended for RGBW and tunable white LEDs.

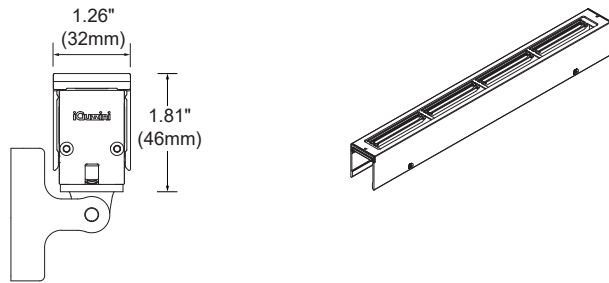

**A5- Honeycomb louver**

Recommended only for elliptical optic.

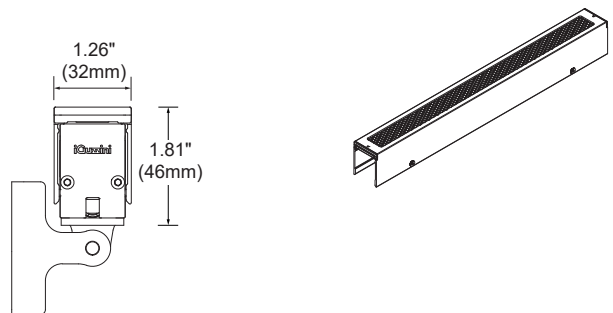

**A6- Visor + transversal louver**

Recommended only for spot and elliptical optics.

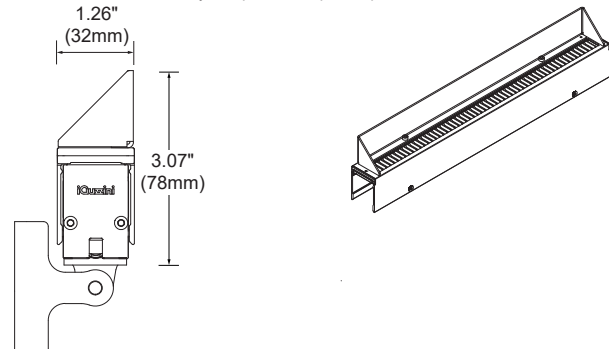

**A7- Linear prismatic screen**

Not recommended for elliptical optic.

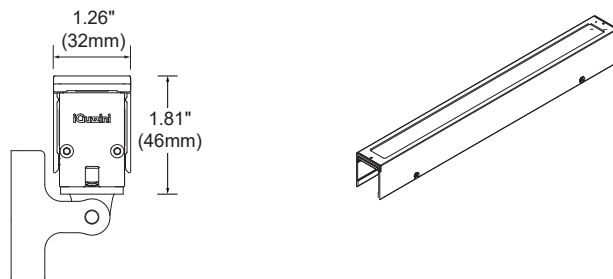

**A8- Protective frame (For IK10)**

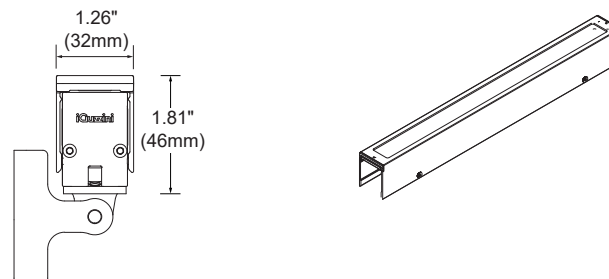

## REMOTE LED DRIVER OPTIONS (TO BE ORDERED SEPARATELY)

PRODUCT CODE

### INDOOR RATED DRIVERS

Driver box model	Min-max		
	RGBW 4.5W/ft (SP, WGS, WGM, WGWF, ELL)	RGBW NO DOT 5W/ft (GL, WG)	TUNABLE WHITE 3.9W/ft
4449-0024A-060-UNV-LDMX/DA	up to 20ft of Linealuce module per feed	up to 11ft of Linealuce module per feed	up to 20ft of Linealuce module per feed
4449-0024A-100-UNV-LDMX/DA	23ft (13ft of Linealuce module per feed)	20ft (11ft of Linealuce module per feed)	25ft (20ft of Linealuce module per feed)

### OUTDOOR RATED DRIVERS

Driver box model	Min-max		
	RGBW 4.5W/ft (SP, WGS, WGM, WGWF, ELL)	RGBW NO DOT 5W/ft (GL, WG)	TUNABLE WHITE 3.9W/ft
4555-0024A-060-UNV-LDMX/DA	up to 13ft of Linealuce module per feed	up to 11ft of Linealuce module per feed	up to 20ft of Linealuce module per feed
4555-0024A-100-UNV-LDMX/DA	23ft (13ft of Linealuce module per feed)	20ft (11ft of Linealuce module per feed)	25ft (20ft of Linealuce module per feed)

### DRIVER BOX MODEL DESCRIPTION

DIMENSION	CONSTANT VOLTAGE	WATTAGE	VOLTAGE	DIMMING PROTOCOL	
<b>4449</b> 12" x 8" x 4" (305 x 203 x 101mm)	<b>0024A</b> 24 Vdc adjustable from 22 to 27Vdc via a built in potentiometer	<b>060 to 100</b> 60W to 100W	<b>UNV</b> 120-277V	<b>LDMX/DA</b> DALI or DMX Max distance: 13ft for 4.5W/ft, 11ft for 5W/ft or 20ft for 3.9W/ft (see wiring diagram page 5) (down to 0.1%)	*Calculated for 24 AWG cable on a 13ft, 11ft or 20ft line with Vstart 25V. With bigger gauge from remote driver to relay wet location junction box, you can achieve longer distance. Consult installation sheet or contact factory for longer remote distance. See wiring diagram page 5.
<b>4555</b> 13" x 9" x 4.5" (330 x 228 x 114mm)					







### ACCESSORIES

(TO BE ORDERED SEPARATELY)

Consult instruction sheet for detail on installation.

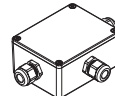

### CABLE

RGBW	TW		RGBW	TW	
<input type="checkbox"/> IX751	<input type="checkbox"/> IX720	2ft (600mm) ø0.15in cable with male/female connector. 24AWG, black. 	<input type="checkbox"/> IX716	<input type="checkbox"/> IX290	10ft (3000mm) ø0.15in cable with female connector. 24AWG, black. 
<input type="checkbox"/> IX752	<input type="checkbox"/> IX721	5ft (1500mm) ø0.15in cable with male/female connector. 24AWG, black. 	<input type="checkbox"/> IX717	<input type="checkbox"/> IX291	16ft (5000mm) ø0.15in cable with female connector. 24AWG, black. 
<input type="checkbox"/> IX714	<input type="checkbox"/> IX774	1ft (350mm) ø0.15in cable with female connector. 24AWG, black. 	<input type="checkbox"/> IX719	<input type="checkbox"/> IX293	5ft (1500mm) ø0.15in cable with male connector. 24AWG, black. 
<input type="checkbox"/> IX715	<input type="checkbox"/> IX289	5ft (1500mm) ø0.15in cable with female connector. 24AWG, black. 	<input type="checkbox"/> <b>4543-00</b> Wet location junction box. Aluminium unfinished. Includes 3 cable clamp for ø3/16 to 7/16in cable and 1 plug. 		

**SUGGESTED WIRING DIAGRAM FOR RGBW**

Consult instruction sheet for wiring details and calculation.

LED DRIVER CODE : **4XXX-0024-060-UNV-LDMX/DA**

Wmax for in line with 4.5W/ft: 58.5W - 13ft (3.9m)

Wmax for driver box: 60W

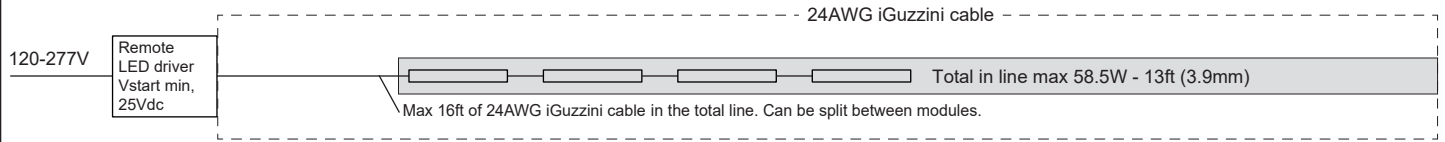

LED DRIVER CODE : **4XXX-0024-100-UNV-LDMX/DA**

Wmax for in line with 4.5W/ft: 58.5W - 13ft (3.9m)

Wmax for driver box: 100W

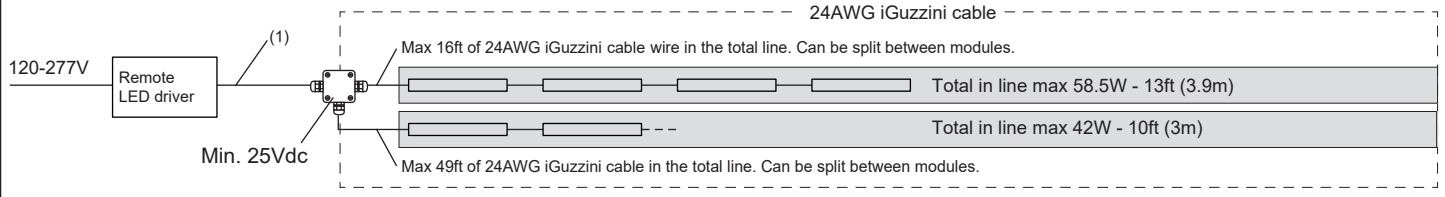

**SUGGESTED WIRING DIAGRAM FOR RGBW NO DOT**

LED DRIVER CODE : **4XXX-0024-100-UNV-LDMX/DA**

Wmax for in line with 5W/ft: 54W - 11ft (3.3m)

Wmax for driver box: 100W

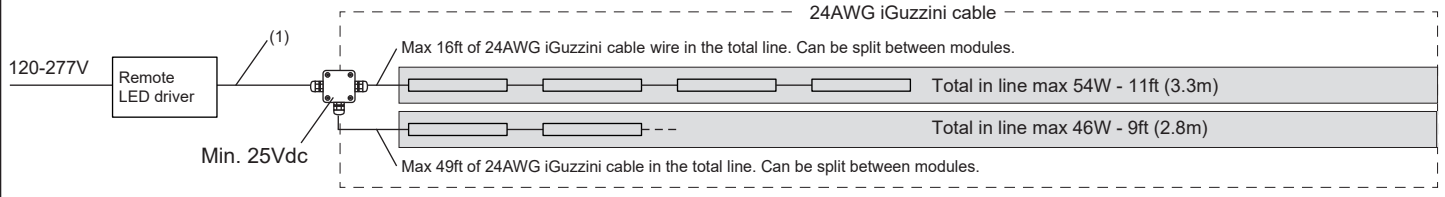

**SUGGESTED WIRING DIAGRAM FOR TUNABLE WHITE**

LED DRIVER CODE : **4XXX-0024-100-UNV-LDMX/DA**

Wmax for in line with 3.9W/ft: 78W - 20ft (6m)

Wmax for driver box: 100W

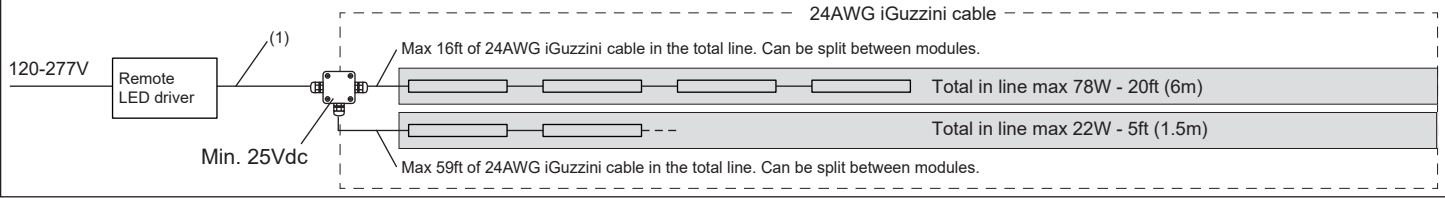

(1) Cable by other. Cable type for TW: Outdoor rated Ø3/16" to 7/16" 3/20AWG minimum.  
 for RGBW: Outdoor rated Ø3/16" to 7/16" 5/20AWG minimum.

**DIMENSIONS**

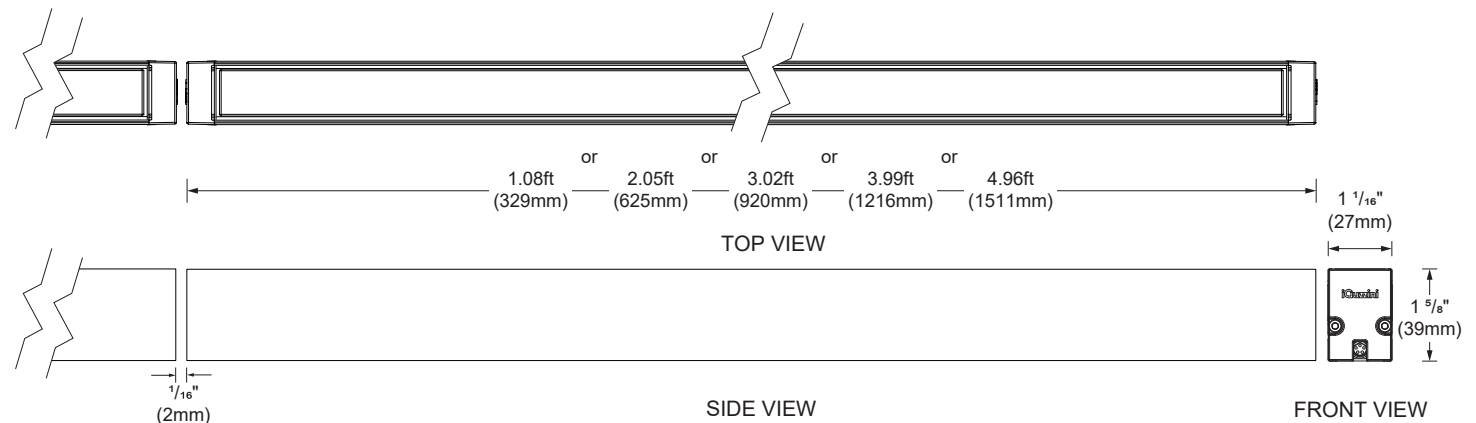

**MOUNTING AND DIMENSIONS**

Consult instruction sheet for detail on installation.

**S1 - SURFACE FLAT-FIX INSTALLATION**

Plate for flat surface mounting (X760).  
 For Linealuce 27 1ft module (L=329mm).  
 Need a width clearance of 2<sup>5</sup>/<sub>8</sub>" (67mm) to install.\*

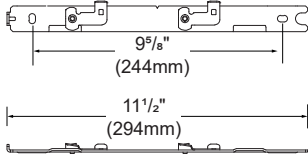

Plate for flat surface mounting (X693).  
 For Linealuce 27 2ft and 3ft module (L=628 and 920mm).  
 Need a width clearance of 2<sup>5</sup>/<sub>8</sub>" (67mm) to install.\*

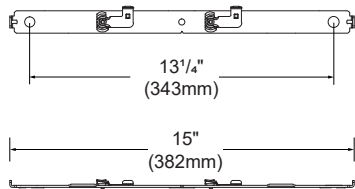
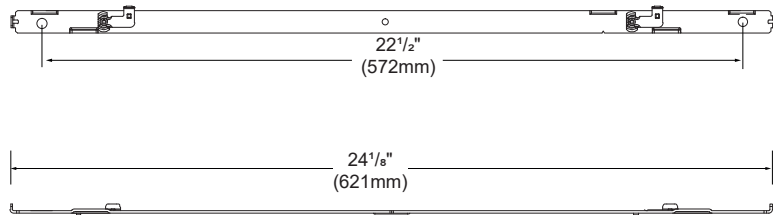
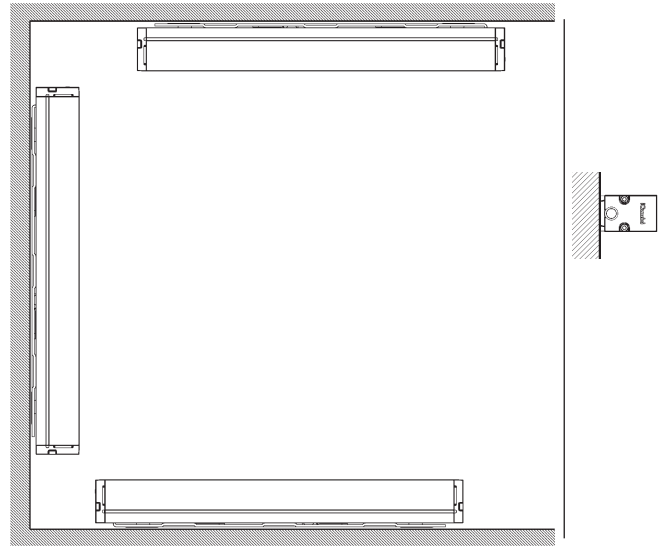

Plate for flat surface mounting (X694).  
 For Linealuce 27 4ft and 5ft module (L=1216 and 1511mm).  
 Need a width clearance of 2<sup>5</sup>/<sub>8</sub>" (67mm) to install.\*



**PERMITTED INSTALLATION POSITION**



\*Need minimum width clearance of 2<sup>5</sup>/<sub>8</sub>" (67mm) to install.

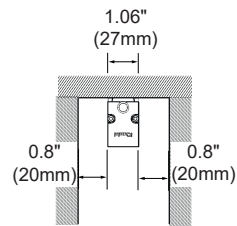

Dimension when tab are opened

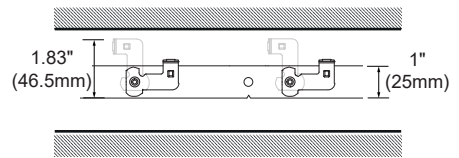

## MOUNTING AND DIMENSIONS

Consult instruction sheet for detail on installation.

### ARM INSTALLATION FOR HEIGHTS LESS THAN 9.5ft (3m)

M2-M3 - Adjustable arms L=1<sup>5</sup>/<sub>8</sub>"(41mm)  
(X688)

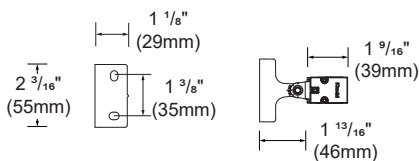

M4-M5 Adjustable arms L=2<sup>3</sup>/<sub>4</sub>"(71mm)  
(X689)

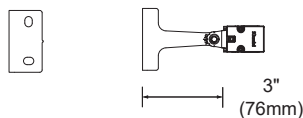

M6-M7 - Adjustable arms L=4<sup>3</sup>/<sub>4</sub>"(121mm)  
(X690)

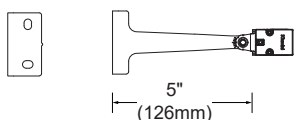

M8-M9 - Adjustable arms L=8<sup>3</sup>/<sub>8</sub>"(221mm)  
(X691)

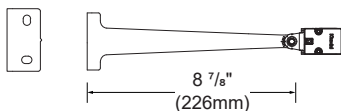

### PERMITTED INSTALLATION POSITION

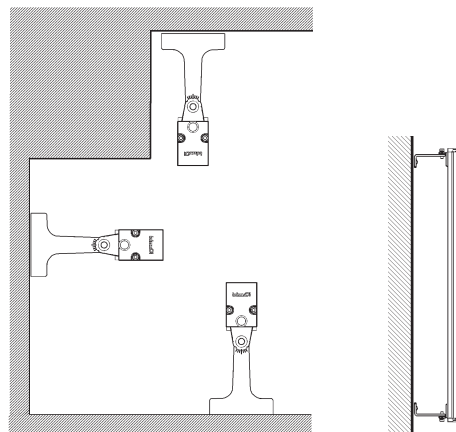

### ARM INSTALLATION FOR HEIGHTS MORE THAN 9.5ft (3m)

U2-U3 - Adjustable arms L=1<sup>5</sup>/<sub>8</sub>"(41mm)  
(X688)

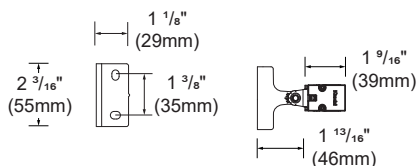

Weight	EPA
0.44lb (0.20kg)	0.022ft <sup>2</sup> (0.002m <sup>2</sup> )

U4-U5 - Adjustable arms L=2<sup>3</sup>/<sub>4</sub>"(71mm)  
(X770)

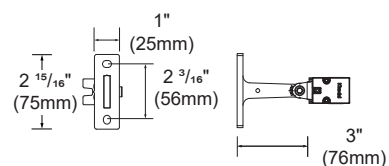

Weight	EPA
0.68lb (0.31kg)	0.022ft <sup>2</sup> (0.002m <sup>2</sup> )

U6-U7 - Adjustable arms L=5"(121mm)  
(X771)

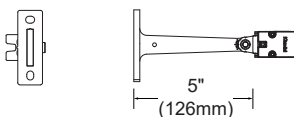

Weight	EPA
0.88lb (0.40kg)	0.032ft <sup>2</sup> (0.003m <sup>2</sup> )

U8-U9 - Adjustable arms L=8<sup>3</sup>/<sub>8</sub>"(221mm)  
(X772)

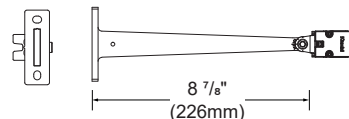

Weight	EPA
1.34lb (0.61kg)	0.075ft <sup>2</sup> (0.007m <sup>2</sup> )

### PERMITTED INSTALLATION POSITION

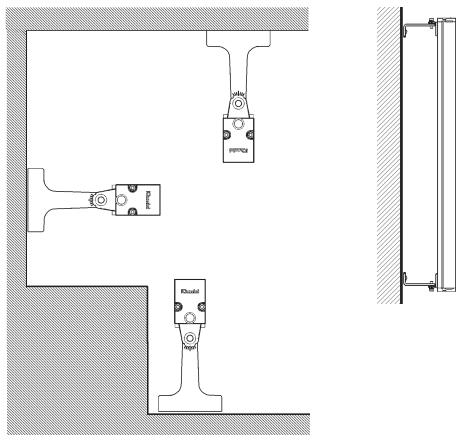

MODELS	EPA*
<b>01</b> - length 1.08' (329mm)	0.33ft <sup>2</sup> (0.031m <sup>2</sup> )
<b>02</b> - length 2.05' (625mm)	0.64ft <sup>2</sup> (0.059m <sup>2</sup> )
<b>03</b> - length 3.02' (920mm)	0.95ft <sup>2</sup> (0.088m <sup>2</sup> )
<b>04</b> - length 3.99' (1216mm)	1.25ft <sup>2</sup> (0.116m <sup>2</sup> )
<b>05</b> - length 4.96' (1511mm)	1.56ft <sup>2</sup> (0.145m <sup>2</sup> )

\* Calculated with visor accessory.

To have the total EPA, add all the value EPA items in composition  
Consult page 9 for other length composition

**MOUNTING AND DIMENSIONS**

Consult instruction sheet for detail on installation.

**SPIKE IN SOIL WITH PIVOT ARM**

(To be used together with arms)

G2-G3 Spike with adjustable arm 1-5/8"(41mm)

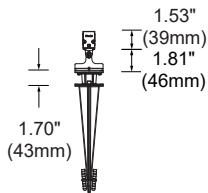

**PERMITTED INSTALLATION POSITION**

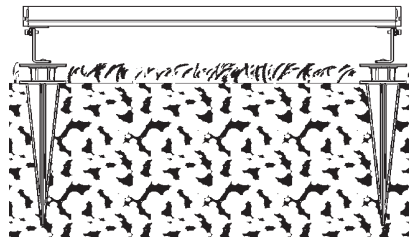

G2 to G9 layout type for 1ft to 5 ft module.

G4-G5 Spike with adjustable arm 2-3/4"(71mm)

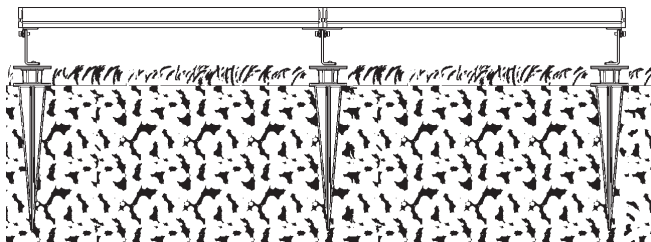
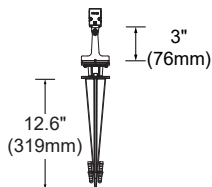

G2 to G9 layout type for 6ft to 20ft length.

G6-G7 Spike with adjustable arm 4-3/4"(121mm)

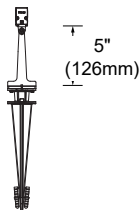

G8-G9 Spike with adjustable arm 8-3/4"(221mm)

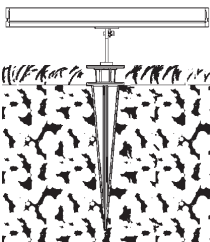
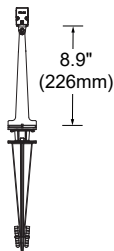

G10-G11 layout for 1ft module



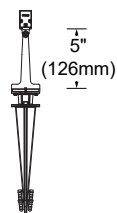

G10-G11 Spike with plate support arm 4-3/4"(121mm)  
 (only for Linealuce 27 surface, 1ft (329mm) module)





**LENGTHS**

Except for 1ft units, all units are equipped with 2 connectors (male/female) for through wiring.  
 1ft units are equipped with 1 male connector.

Nominal length	Exact length
1	 L: 1.08ft (329mm)
2	 L: 2.05ft (625mm)
3	 L: 3.02ft (920mm)
4	 L: 3.99ft (1216mm)
5	 L: 4.96ft (1511)

**CONTINUOUS ROW MODULE**

Length 6ft to 20ft are continuous row module compositions. See compositions below.  
 \*Note that 2mm spacing minimum is required for continuous rows installation.

Nominal length	Exact length	Single elements qty
6	6.04ft (1842mm)	2 x 3ft
7	7.01ft (2138mm)	1 x 3ft + 1 x 4ft
8	7.99ft (2434mm)	2 x 4ft
9	8.95ft (2729mm)	1 x 4ft + 1 x 5ft
10	9.92ft (3024mm)	2 x 5ft
11	11.01ft (3355mm)	2 x 5ft + 1 x 1ft
12	11.98ft (3651mm)	2 x 5ft + 1 x 2ft
13	12.95ft (3946mm)	2 x 5ft + 1 x 3ft
14	13.91ft (4242mm)	2 x 5ft + 1 x 4ft
15	14.89ft (4537mm)	3 x 5ft
16	15.98ft (4868mm)	3 x 5ft + 1 x 1ft
17	16.94ft (5164mm)	3 x 5ft + 1 x 2ft
18	17.91ft (5459mm)	3 x 5ft + 1 x 3ft
19	18.88ft (5755mm)	3 x 5ft + 1 x 4ft
20	19.84ft (6050mm)	4 x 5ft

**OPTIC OVERVIEW**

**SYMMETRICAL**

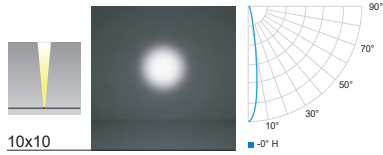
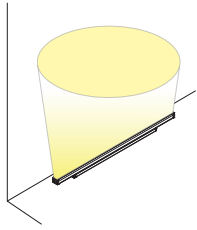

**GRAZER**

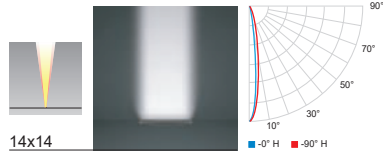
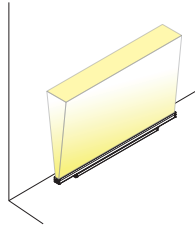

**ELLIPTICAL**

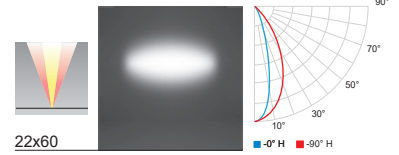
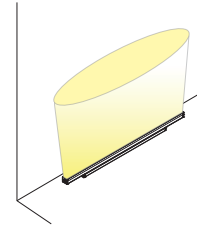

**GENERAL LIGHT NO DOT**

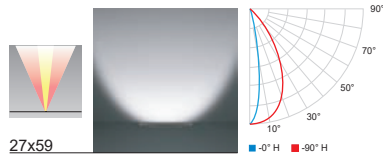
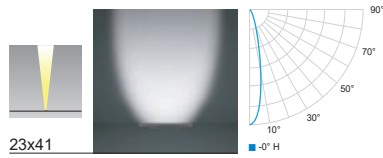
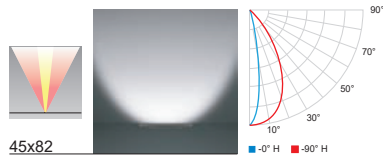

**GRAZER NOT DOT**

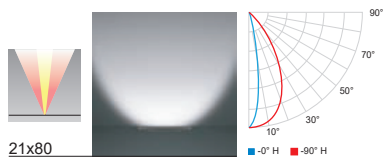

## PHOTOMETRIC DATA

Power can vary with selected drivers. Efficacy based on IESNA LM-79 test reports.

### SPOT 10x10



MODEL	CCT (K)	CRI	POWER (W/ft)	LUMENS (lm/ft)	EFFICACY (lm/w)	MAX CANDELA (cd)
RGBW	3000K	80	4.5W/ft	260	65	1 403
	3500K			TBC	TBC	TBC

SPOT RGBW (3000K, 80CRI)

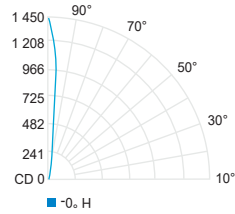

### GENERAL LIGHT NO-DOT

45x82



MODEL	CCT (K)	CRI	POWER (W/ft)	LUMENS (lm/ft)	EFFICACY (lm/w)	MAX CANDELA (cd)
RGBW	3000K	80	5W/ft	112	24	97
	3500K			TBC	TBC	TBC

General Light no-dot (3000K, 80CRI)

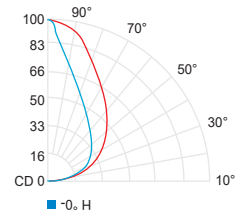

### WALL GRAZER SPOT

14x14



MODEL	CCT (K)	CRI	POWER (W/ft)	LUMENS (lm/ft)	EFFICACY (lm/w)	MAX CANDELA (cd)
TUNABLE WHITE	2200K	80	3.9W/ft	270	71	1 015
	3000K			290	76	1 091
	2700K					
RGBW	3000K	80	4.5W/ft	214	53	728
	3500K			TBC	TBC	TBC

WGS TW (2200K-3000K, 80CRI)

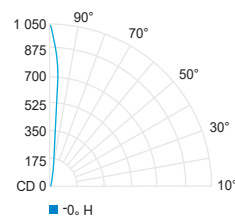

WGS TW (2700K-4000K, 80CRI)

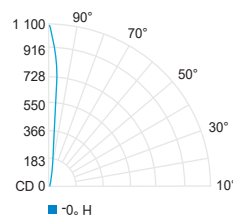

WGS RGBW (3000K, 80CRI)

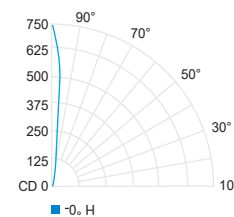

## PHOTOMETRIC DATA

Power can vary with selected drivers. Efficacy based on IESNA LM-79 test reports.

### WALL GRAZER MEDIUM

23x41



MODEL	CCT (K)	CRI	POWER (W/ft)	LUMENS (lm/ft)	EFFICACY (lm/w)	MAX CANDELA (cd)
TUNABLE WHITE	2200K	80	3.9W/ft	259	68	505
	3000K			279	73	543
	2700K		4.5W/ft	197	49	379
	4000K			TBC	TBC	TBC
RGBW	3000K	80	4.5W/ft	TBC	TBC	TBC
	3500K			TBC	TBC	TBC

WGM TW (2200K-3000K, 80CRI)

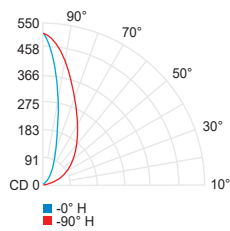

WGM TW (2700K-4000K, 80CRI)

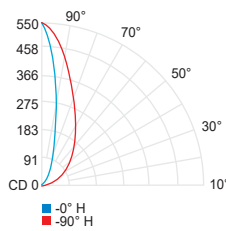

WGM RGBW (3000K, 80CRI)

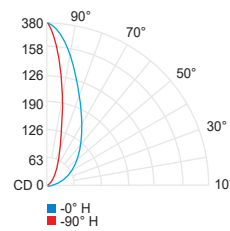

### WALL GRAZER WIDE FLOOD

27x59



CCT (K)	CCT (K)	CRI	POWER (W/ft)	LUMENS (lm/ft)	EFFICACY (lm/w)	MAX CANDELA (cd)
TUNABLE WHITE	2200K	80	3.9W/ft	238	62	377
	3000K			256	67	405
	2700K		4.5W/ft	180	45	277
	4000K			TBC	TBC	TBC
RGBW	3000K	80	4.5W/ft	TBC	TBC	TBC
	3500K			TBC	TBC	TBC

WGWF TW (2200K-3000K, 80CRI)

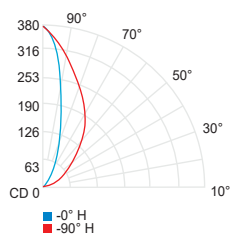

WGWF TW (2700K-4000K, 80CRI)

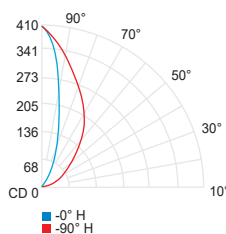

WGWF RGBW (3000K, 80CRI)

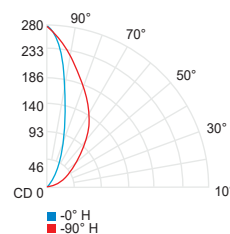

## PHOTOMETRIC DATA

Power can vary with selected drivers. Efficacy based on IESNA LM-79 test reports.

### WALL GRAZER NO-DOT

21x80



MODEL	CCT (K)	CRI	POWER (W/ft)	LUMENS (lm/ft)	EFFICACY (lm/w)	MAX CANDELA (cd)
RGBW	3000K	80	5W/ft	87	17	104
	3500K			TBC	TBC	TBC

Wall grazer no-dot (3000K, 80CRI)

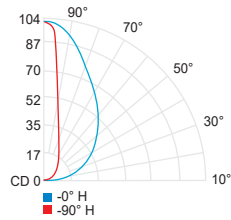

### ELLIPTICAL

22x60



MODEL	CCT (K)	CRI	POWER (W/ft)	LUMENS (lm/ft)	EFFICACY (lm/w)	MAX CANDELA (cd)
RGBW	3000K	80	4.5W/ft	226	56	401
	3500K			TBC	TBC	TBC

ELL RGBW (3000K, 80CRI)

