

Collection of recessed downlights for architectural applications<sup>1</sup>. Excellent build quality with features for the most demanding professional applications. Available with complete light distributions offering fixed, adjustable and wall washer optics. Generous light outputs with excellent chromatic performance and enhanced visual comfort (UGR<10).

<sup>(1)</sup> Related products in the same family for other sizes: Laser 17, Laser 25, Laser 38 and Laser 75.

**Luminaire characteristic:** Power input system (IC, CP): 20W, 16W or 12W  
Power input system (RF, NC): 23W, 19W or 15W  
Lumens for 3000K, 90CRI: Up to 1900lm  
Luminaire efficacy for 3000K, 90CRI: Up to 95lm/W

**Source:** COB LED module  
2700K: 90CRI,  
3000K: 90CRI,  
3500K: 90CRI,  
4000K: 90CRI.

**Lumen maintenance:** 90% of initial lumens at 50 000 hours - L90 B10 (Ta 77°F / 25°C, LM-80)

**Optic:** Deep recessed reflector available with medium, flood or very wide flood optic. Visual comfort: Up to UGR<10  
Optical assembly hot aiming adjustment:  
• Comfort optic type: 30° tilt.  
• Super comfort optic type: 30° tilt and 355°pan.  
• Wall washer: Wall washer with lens.

**Material:** Body: Die-cast aluminum optical assembly  
Reflector: Metalized polycarbonate  
Baffle: Painted thermoplastic  
Housing: Galvanized steel

**Mounting:** Cut-out:  $\varnothing 3\frac{3}{4}"$  ( $\varnothing 96\text{mm}$ )  
Remodel.  
New construction with plaster frame.  
New construction with housing suitable for insulated ceiling or Chicago plenum (page 4-5).

**Electrical:** Integral high efficiency LED driver rated at 50 000 hours, 120V or 277V.

**Dimming:** Leading edge (TRIAC) and trailing edge (ELV) (120V only): down to 1%.  
0-10V (120-277V): down to 1%  
DALI (120-277V): down to 1%

**Finish:** Powder-coated body and painted metallized baffle. See page 2 for complete offering.

**Weight:** Up to 1.01lb (0.46kg)

**Warranty:** 5 year limited warranty.

**Rating:** IP20, IP44 (under the ceiling for trim fixed)  
IP20, IP23 (under the ceiling for trim adjustable)

**Certification:**  cULus listed for damp location. Interior use only.

N.B. THE DIMENSIONS AND THE IMAGES MAY DIFFER FROM THE ACTUAL PRODUCT DEPENDING ON THE CONFIGURATION. (E.g., OPTIC TYPE, OPTIC AND FINISH.)

## ORDERING INFO



PRODUCT CODE				INSTALLATION CODE					
SHAPE	TRIM STYLE	INSTALLATION	LED	OPTIC TYPE	OPTIC	VOLTAGE	FINISH (trim finish / baffle finish)	DIMMING*	
<b>R</b> Round	<b>T</b> Trim	<b>RF</b> Remodel	<b>927</b> 2700K, 90CRI	<b>SGF</b> Comfort fixed	<b>MD</b> Medium 18°	<b>120</b> 120V	<b>01</b> White / black		<b>RF, NC (INSTALLATION)</b>  120V (120) <b>LTE</b> Leading and Trailing edge dimming (down to 1%) <b>D01</b> 0-10V (down to 1%) <b>DA</b> <sup>4</sup> DALI (down to 1%)  277V (277) <b>D01</b> 0-10V (down to 1%) <b>DA</b> <sup>4</sup> DALI (down to 1%)
		<b>NC</b> New construction	<b>930</b> 3000K, 90CRI	<b>SGA</b> Comfort adjustable	<b>FL</b> Flood 30°/28°	<b>277</b> <sup>2</sup> 277V	<b>02</b> Black / black		
		<b>IC</b> Insulated ceiling housing	<b>935</b> 3500K, 90CRI	<b>SCF</b> Super comfort fixed	<b>WF</b> Wide flood 46°/54°/56°	<b>UNV</b> <sup>3</sup> 120-277V	<b>31</b> White / white		
		<b>CP</b> Chicago plenum housing	<b>940</b> 4000K, 90CRI	<b>SCA</b> Super comfort adjustable			<b>41</b> <sup>4</sup> White / gold		
				<b>FWW</b> <sup>1</sup> Fixed wall washer			<b>E4</b> <sup>4</sup> White / chrome		<b>IC, CP (INSTALLATION)</b>  120V (120) <b>LTE</b> Leading and Trailing edge dimming (down to 1%)  120-277V (UNV) <b>D01</b> 0-10V (down to 1%) <b>DA</b> <sup>4</sup> DALI (down to 1%)
						<b>E7</b> <sup>4</sup> White / black chrome			
						<b>E9</b> <sup>4</sup> White / gold matte			

<sup>(1)</sup> No optic selection necessary when ordering the fixed wall washer (FWW) optic type.  
<sup>(2)</sup> Available for remodel (RF) and new construction (NC) installation.  
<sup>(3)</sup> Available for insulated ceiling (IC) and Chicago plenum (CP) housing installation.  
<sup>(4)</sup> May require a longer lead time than standard. Please contact customer service for details.  
 \* Dimming levels will vary depending on the dimmer used and the number of luminaires on the line.



01 White / Black



02 Black / Black



31 White / White



41 White / Gold



E4 White / Chrome



E7 White / Black chrome

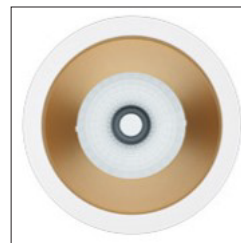

E9 White / Gold matte

**TRIM MODELS DIMENSIONS**

FIXED OPTIC

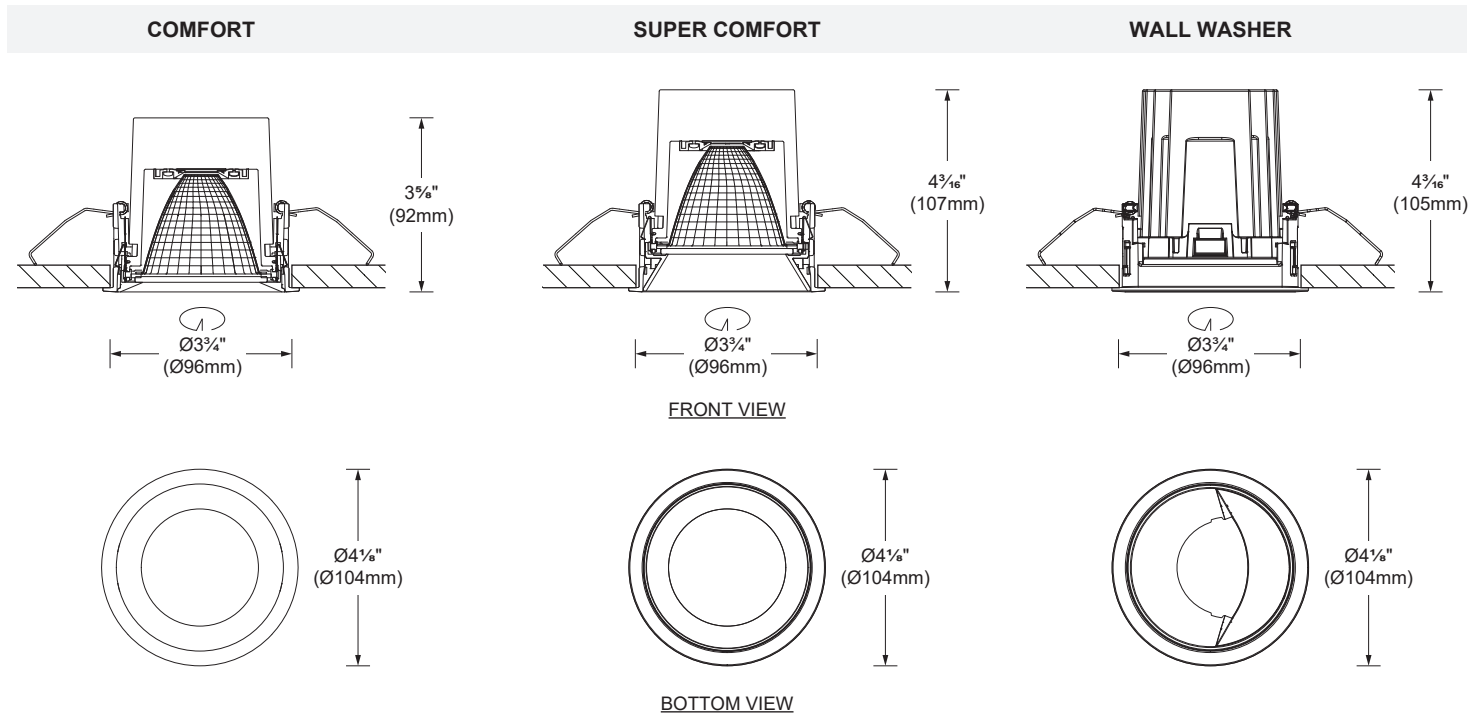

ADJUSTABLE OPTIC

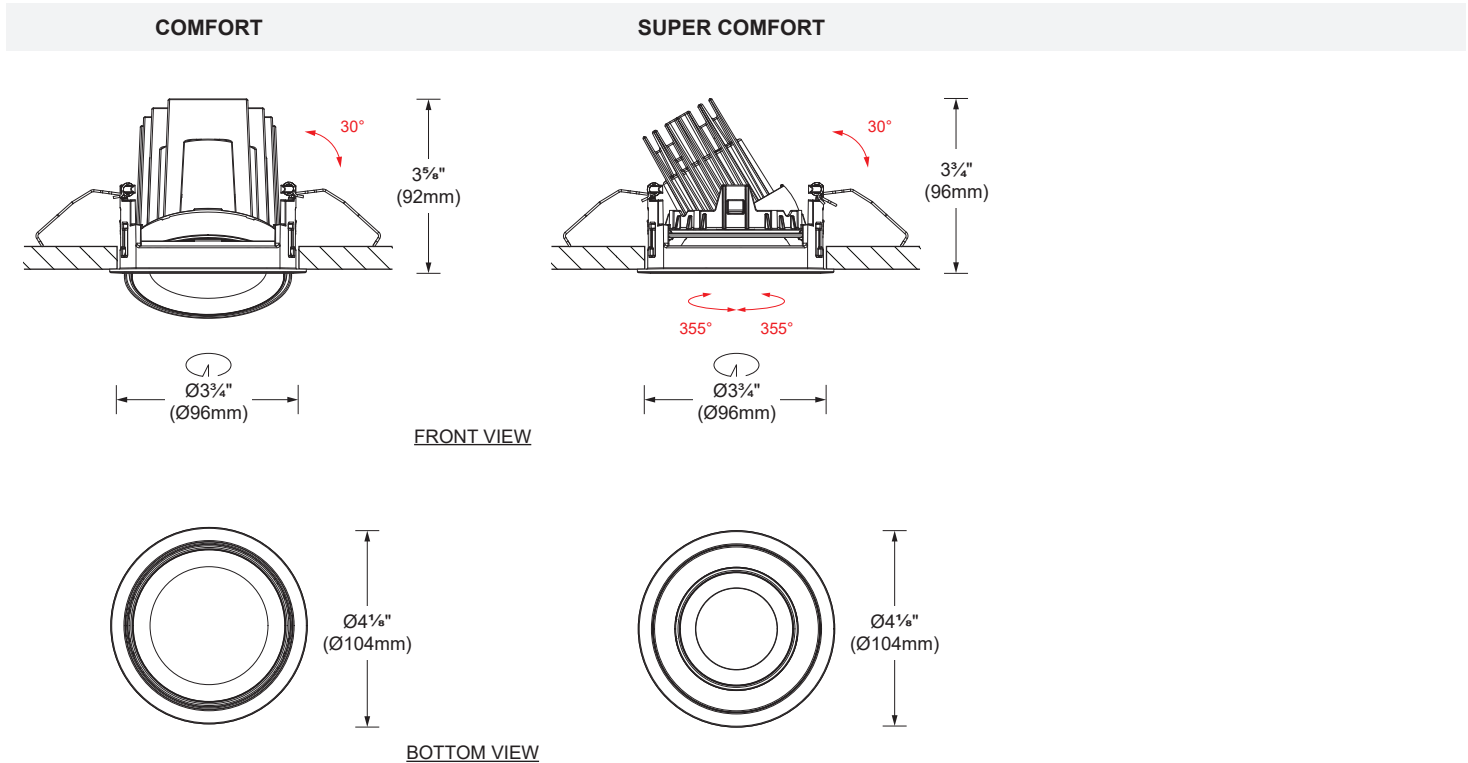

## INSTALLATION

### Remodel (RF)

Versatile fixture for new or existing ceiling structure. Suitable for non-insulated ceiling assemblies, like sheetrock, or paneling. Fixture is ready for remodeling installation.

**Ceiling thickness:** 1/8" to 1 1/2" (1mm - 38mm)

**Total weight:**  
Trim: up to 3 lb (1.4 kg)

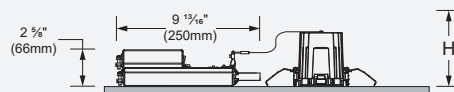

Model	Mounting	Cut-out dimension $\odot$	Clearance (H)
Laser 96	Trim	$\varnothing$ 3 3/4" ( $\varnothing$ 96mm)	6 1/2" (165mm)

### New construction with plaster frame (NC)

Plaster frame with hanger bars system to be installed during rough-in phase. Suitable for non-insulated ceiling assemblies, like sheetrock, or paneling. Plaster frame and trim can be shipped separately.

**Ceiling thickness:**  
Trim: 1/8" to 1 1/2" (1mm - 38mm)

**Total weight:**  
Trim: up to 6 lb (2.7 kg)

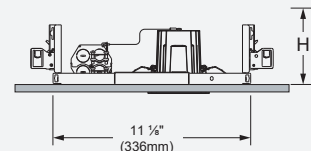
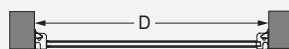

Hanger bars suitable for Grid ceiling

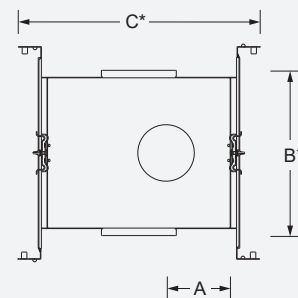
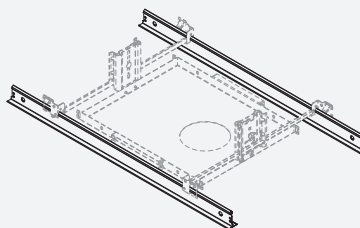

\*Provide a minimum of 1 7/8" (46mm) on each side for the hanger bar fixations

Model	Plaster frame	Cut-out dimension $\odot$	Cut-out position (A)	Max Overall dimensions (B*xC*)	Hanger bars (D)	Clearance (H)
Laser 96	BN-LAS96RT-NC	$\varnothing$ 3 3/4" ( $\varnothing$ 96mm)	4 5/16" (110mm)	11" x 16 1/8" (280 x 410mm)	14 1/4" to 26" (362 to 660mm)	6 1/2" (165mm)

## INSTALLATION

### New construction with housing suitable for insulated ceiling (IC) or Chicago plenum (CP)

Housing with hanger bars system for new construction installations. Suitable for insulated ceiling or Chicago plenum applications. Housing and trim can be shipped separately.

#### Ceiling thickness:

Trim: 1/16" to 1 1/2" (1mm - 38mm)

#### Total weight:

Trim: 8.2 lb (3.7 kg)

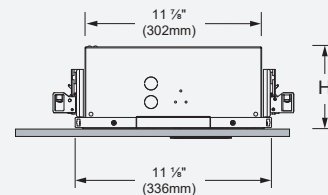
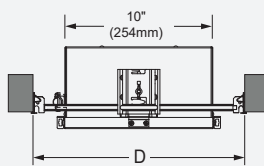

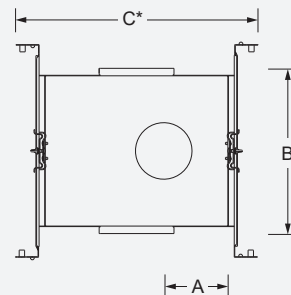
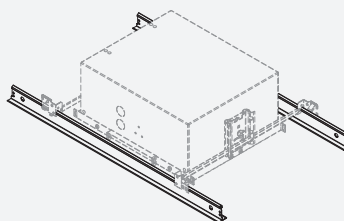

Hanger bars suitable for Grid ceiling



\*Provide a minimum of 1 1/8" (46mm) on each side for the hanger bar fixations

Model	Housing	Cut-out dimension 	Cut-out position (A)	Max Overall dimensions (B*xC*)	Hanger bars (D)	Clearance (H)
Laser 96	BI-LAS96RT-IC/CP	Ø 3 3/4" (Ø 96mm)	4 5/16" (110mm)	11" x 16 1/8" (280 x 410mm)	14 1/4" to 26" (362 to 660mm)	5 1/2" (140mm)

## ACCESSORIES (TO BE ORDERED SEPARATELY)

	PRODUCT CODE	COMFORT FIXED	COMFORT ADJUSTABLE	SUPER COMFORT FIXED	SUPER COMFORT ADJUSTABLE
REFRACTOR LENS (for elliptical distribution) 	IPC86.024 - Clear transparent	<input type="checkbox"/>	<input type="checkbox"/>	<input type="checkbox"/>	
REFRACTOR LENS (for elliptical distribution - medium) 	MY24.024 - Clear transparent				<input type="checkbox"/>
INTERNAL ANTI-GLARE RING (for White Trim finish - 31, 41, E4, E7, E9) 	PC90.004 - Black		<input type="checkbox"/>		

## PHOTOMETRIC DATA

### COMFORT FIXED



CCT (K)	CRI	LOAD (W)	OPTIC	LUMENS (lm)	EFFICACY (lm / W)	MAX CANDELA (cd)	MODELS
3000K	90	20W*	Medium 18°	1 746	87	9 987	ILAS96RX-XX-930-SGFMD
			Flood 30°	1 812	90	6 408	ILAS96RX-XX-930-SGFLL
			Wide flood 56°	1 878	93	2 392	ILAS96RX-XX-930-SGFWF

\* System power is the maximum measured value considering the Power Factor.

For Non-IC (RF and NC installation), the system power could be increased up to 23W.

Use multiplier table for other CCT and CRI output data. Efficacy based on IESNA LM-79 test reports. Visit [iguzzini.com/us](http://iguzzini.com/us) for complete photometric data.

Medium 18° (3000K, 90CRI)

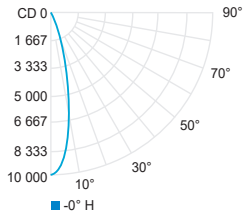

Center beam fc	Beam width ft
2ft	2 497 0.7
4ft	624 1.3
6ft	277 2.0
8ft	156 2.6
10ft	100 3.3
12ft	69.4 4.0

Flood 30° (3000K, 90CRI)

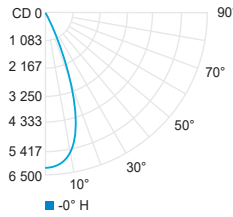

Center beam fc	Beam width ft
2ft	1 602 1.1
4ft	401 2.1
6ft	178 3.2
8ft	100 4.3
10ft	64.1 5.4
12ft	44.5 6.4

Wide flood 56° (3000K, 90CRI)

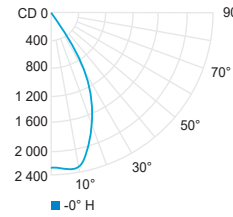

Center beam fc	Beam width ft
2ft	598 2.1
4ft	150 4.2
6ft	66.5 6.3
8ft	37.4 8.4
10ft	23.9 10.4
12ft	16.6 12.5

### COMFORT ADJUSTABLE



CCT (K)	CRI	LOAD (W)	OPTIC	LUMENS (lm)	EFFICACY (lm / W)	MAX CANDELA (cd)	MODELS
3000K	90	20W*	Medium 18°	1 753	87	10 033	ILAS96RX-XX-930-SGAMD
			Flood 30°	1 820	91	6 437	ILAS96RX-XX-930-SGAFL
			Wide flood 56°	1 887	94	2 403	ILAS96RX-XX-930-SGAWF

\* System power is the maximum measured value considering the Power Factor.

For Non-IC (RF and NC installation), the system power could be increased up to 23W.

Use multiplier table for other CCT and CRI output data. Efficacy based on IESNA LM-79 test reports. Visit [iguzzini.com/us](http://iguzzini.com/us) for complete photometric data.

Medium 18° (3000K, 90CRI)

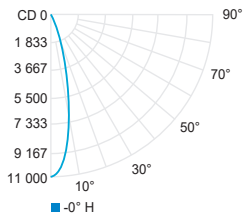

Center beam fc	Beam width ft
2ft	2 508 0.7
4ft	627 1.3
6ft	279 2.0
8ft	157 2.6
10ft	100 3.3
12ft	69.7 4.0

Flood 30° (3000K, 90CRI)

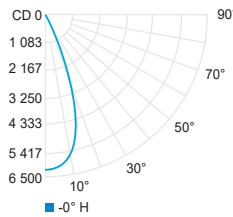

Center beam fc	Beam width ft
2ft	1 609 1.1
4ft	402 2.1
6ft	179 3.2
8ft	101 4.3
10ft	64.4 5.4
12ft	44.7 6.4

Wide flood 56° (3000K, 90CRI)

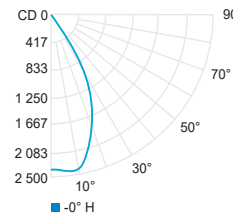

Center beam fc	Beam width ft
2ft	601 2.1
4ft	150 4.2
6ft	66.8 6.3
8ft	37.6 8.4
10ft	24 10.4
12ft	16.7 12.5

CCT options	2700K	3000K	3500K	4000K
CRI options	90CRI	90CRI	90CRI	90CRI
<b>Multiplier</b>	<b>0.94</b>	<b>1</b>	<b>1.02</b>	<b>1.06</b>

## PHOTOMETRIC DATA

### SUPER COMFORT FIXED



CCT (K)	CRI	LOAD (W)	OPTIC	LUMENS (lm)	EFFICACY (lm / W)	MAX CANDELA (cd)	MODELS
3000K	90	20W*	Medium 18°	1 679	83	9 422	ILAS96RX-XX-930-SCFMD
			Flood 30°	1 723	86	6 134	ILAS96RX-XX-930-SCFFL
			Wide flood 54°	1 900	95	2 540	ILAS96RX-XX-930-SCFWF

\* System power is the maximum measured value considering the Power Factor.

For Non-IC (RF and NC installation), the system power could be increased up to 23W.

Use multiplier table for other CCT and CRI output data. Efficacy based on IESNA LM-79 test reports. Visit [iguzzini.com/us](http://iguzzini.com/us) for complete photometric data.

Medium 18° (3000K, 90CRI)

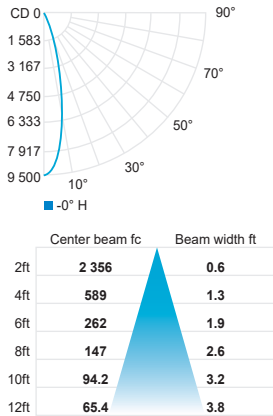

Flood 30° (3000K, 90CRI)

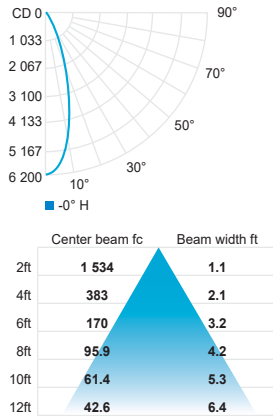

Wide flood 54° (3000K, 90CRI)

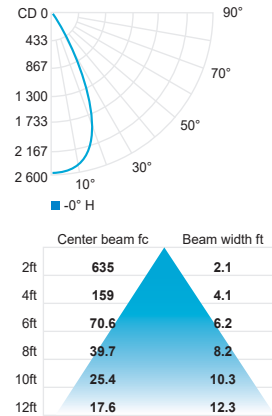

### SUPER COMFORT ADJUSTABLE



CCT (K)	CRI	LOAD (W)	OPTIC	LUMENS (lm)	EFFICACY (lm / W)	MAX CANDELA (cd)	MODELS
3000K	90	12W*	Medium 18°	1082	90	6 499	ILAS96RX-XX-930-SCAMD
			Flood 28°	1095	91	4 399	ILAS96RX-XX-930-SCAFL
			Wide flood 46°	1095	91	2 099	ILAS96RX-XX-930-SCAWF

\* System power is the maximum measured value considering the Power Factor.

For Non-IC (RF and NC installation), the system power could be increased up to 15W.

Use multiplier table for other CCT and CRI output data. Efficacy based on IESNA LM-79 test reports. Visit [iguzzini.com/us](http://iguzzini.com/us) for complete photometric data.

Medium 18° (3000K, 90CRI)

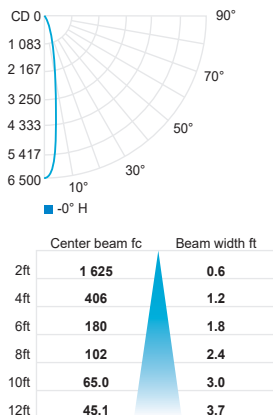

Flood 28° (3000K, 90CRI)

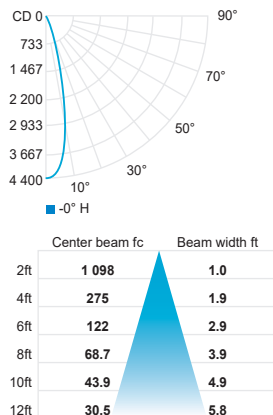

Wide flood 46° (3000K, 90CRI)

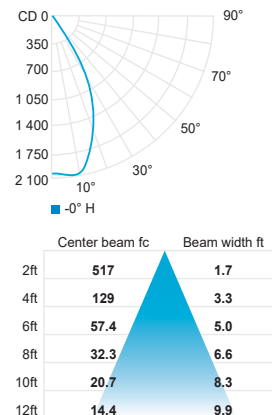

CCT options	2700K	3000K	3500K	4000K
CRI options	90CRI	90CRI	90CRI	90CRI
<b>Multiplier</b>	<b>0.94</b>	<b>1</b>	<b>1.02</b>	<b>1.06</b>

## PHOTOMETRIC DATA

### WALL WASHER



CCT (K)	CRI	LOAD (W)	OPTIC	LUMENS (lm)	EFFICACY (lm / W)	MAX CANDELA (cd)	MODELS
3000K	90	16W*	Wall washer	938	58	706	ILAS96RX-XX-930-FWW

\* System power is the maximum measured value considering the Power Factor.  
For Non-IC (RF and NC installation), the system power could be increased up to 19W.

Use multiplier table for other CCT and CRI output data. Efficacy based on IESNA LM-79 test reports. Visit [iguzzini.com/us](http://iguzzini.com/us) for complete photometric data.

#### Wall washer (3000K, 90CRI)

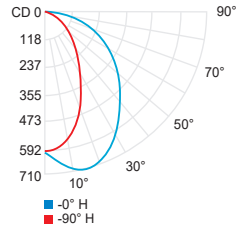

CCT options	2700K	3000K	3500K	4000K
CRI options	90CRI	90CRI	90CRI	90CRI
<b>Multiplier</b>	<b>0.94</b>	<b>1</b>	<b>1.02</b>	<b>1.06</b>