

LE PERROQUET

CEILING SUSPENSION MEDIUM LED

SPECIFICATION SHEET

PAGE: 1 OF 3

Project name: _____

Type: _____



Pendant luminaire for indoor application in institutional and commercial spaces. Base mounted with a patented suspension system that allow rotation and aiming of the luminaire in nearly all directions.

DESIGN BY RENZO PIANO

Luminaire characteristics:

Power input: 24 to 31W

Lumens: 2100 to 2200lm (for 3000K, 90CRI)

Luminaire efficacy: 75lm/W

Source: LED module (LM-80 tested)

4000K : 80CRI,

3000K : 90CRI.

Lumen maintenance: 80% of initial lumens at >50 000 hours (L80), (LM79 tested).

Optics: Available in medium, flood, or wide flood.

Mounting: Ceiling suspension on canopy on a standard 4" Junction box.

Configuration: 360° vertical (pan), and 90° horizontal (tilt) pivoting axes with mechanical aiming lock.

Material:

Body: Die-cast aluminum body and thermoplastic accessory holder ring and driver housing.

Reflector: Formed aluminum

Diffuser: Tempered glass

Hardware: Steel suspension cable

Electrical: High efficiency electronic driver, rated 50 000 hours, 120-277V.

Dimming: Optional Leading (Triac) and trailing edge (ELV)

Finish: Gray (RAL9006)

Weight: 3.2lbs (1.45kg)

Warranty: 5 year limited warranty.

Certification: cULus for damp location.

Ratings: IP20

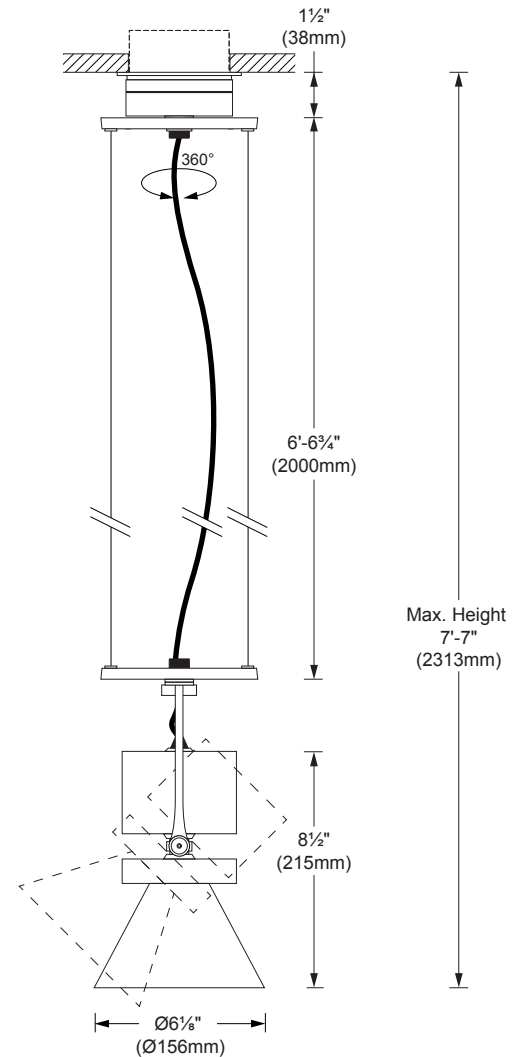

SIDE VIEW

Project name: _____

Type: _____

PHOTOMETRIC DATA

Visit iguzzini.com for complete photometric data

LOAD (W)	CCT (K)	CRI	OPTIC	LUMENS (lm)	EFFICACY (lm / w)	MAX CANDELA (cd)	MODELS
31W	3000K	90	Medium	2 227	75	17 243	I.MP76
29W			Flood	2 216	76	4 964	I.MP77
			Wide Flood	2 186	75	3 641	I.MP78
25W	4000K	80	Medium	2 405	96	17 818	I.MP70
24W			Flood	2 290	95	5 129	I.MP71
			Wide Flood	2 259	94	3 362	I.MP72

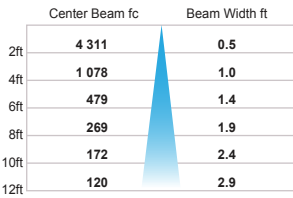

3000K - 90 CRI - 14° Medium

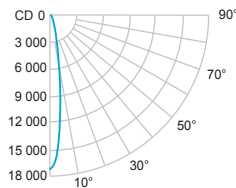

■ -0° H

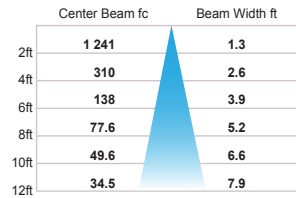

3000K - 90 CRI - 36° Flood

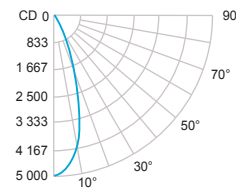

■ -0° H

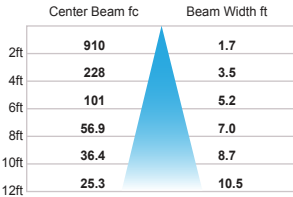

3000K - 90 CRI - 48° Wide Flood

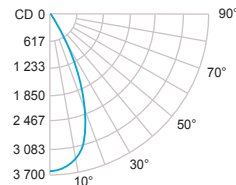

■ -0° H

Project name: _____

Type: _____

ACCESSORIES (TO BE ORDERED SEPARATELY)

* fixture can hold a maximum of 3 accessories at a time

I.9539-24 - Elliptical lens 

I.9529-02 - Black directional flaps 

I.9533-01 - White asymmetrical screen
 I.9533-10 - Gray asymmetrical screen 

I.MXH9-12 - Interchangeable reflector 14°
 I.MX10-12 - Interchangeable reflector 36°
 I.MX11-12 - Interchangeable reflector 48° 

ORDERING INFO

MODEL	VOLTAGE	FINISH	OPTIONAL DIMMING
<input type="radio"/> I.MP70 - 25W, 4000K, 80CRI, Medium <input type="radio"/> I.MP71 - 24W, 4000K, 80CRI, Flood <input type="radio"/> I.MP72 - 24W, 4000K, 80CRI, Wide flood <input type="radio"/> I.MP76 - 31W, 3000K, 90CRI, Medium <input type="radio"/> I.MP77 - 29W, 3000K, 90CRI, Flood <input type="radio"/> I.MP78 - 29W, 3000K, 90CRI, Wide flood	<input type="radio"/> UNV - 120-277V <input type="radio"/> 120 - 120V	<input type="radio"/> 10 - Gray	<input type="radio"/> LTE - Leading and trailing edge dimming (120V only)

DUE TO CONTINUOUS IMPROVEMENTS, THE INFORMATION HEREIN MAY BE CHANGED WITHOUT NOTICE.

LAST UPDATE: September 14, 2018

MH - R9