

SMART ACCESSORIES INTELLIGENT LIGHT SOLUTIONS (ILS)

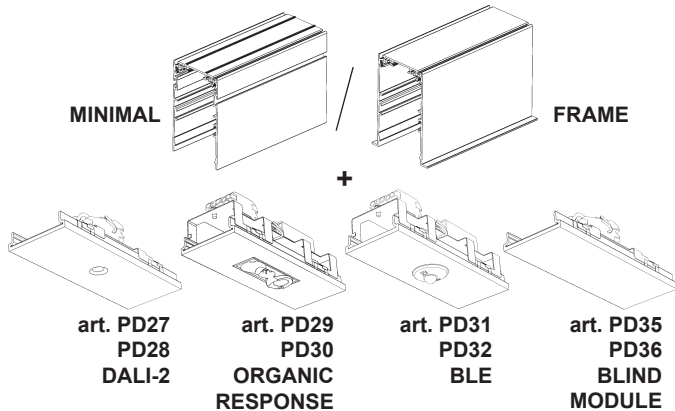

IT ATTENZIONE:

LA SICUREZZA DELL'APPARECCHIO E' GARANTITA SOLO CON L'USO APPROPRIATO DELLE SEGUENTI ISTRUZIONI; PERTANTO E' NECESSARIO CONSERVARLE.

EN WARNING:

THE SAFETY OF THIS FIXTURE IS GUARANTEED ONLY IF YOU COMPLY WITH THESE INSTRUCTIONS; REMEMBER TO CONSERVE IN A SAFE PLACE.

FR ATTENTION:

LA SECURITE DE L'APPAREIL N'EST GARANTIE QU'EN CAS D'UTILISATION CORRECTE DES INSTRUCTIONS SUIVANTES; IL FAUT PAR CONSEQUENT LES CONSERVER.

DE ACHTUNG:

DIE SICHERHEIT DES GERÄTES WIRD NUR DURCH SACHGEMÄSSE BEFOLGUNG NACHSTEHENDER ANWEISUNGEN GEWÄHRLEISTET; IHRE AUFBEWAHRUNG IST DESHALB SEHR WICHTIG.

NL OPGELET:

DE VEILIGHEID VAN DI ATOESTEL IS SLECHTS DAN GEGARANDEERD ALS INDIEN DE VOLGENDE INSTRUCTIES STRIKT WORDEN TOEGEPAST: DAAROM MOET MEN ZE OOK BEWAREN.

ES ATENCION:

LA SEGURIDAD DEL APARATO SE GARANTIZA SOLO CUMPLIENDO CUIDADOSAMENTE LAS SIGUIENTES INSTRUCCIONES; POR ELLO, ES NECESARIO CONSERVARLAS.

DA BEMÆRK:

SIKKERHEDEN VED BRUG AF ARMATURET KAN KUN GARANTERES, HVIS DISSE ANVISNINGER FØLGES; SØRG DERFOR FOR AT GEMME DEM.

NO ADVARSEL:

SIKKERHETEN TIL DETTE APPARATET GARANTERES KUN HVIS DU OVERHOLDER DISSE INSTRUKSJONENE; HUSK Å OPPBEVARE DEM PÅ ET TRYGT STED.

SV OBSERVERA!

UTRUSTNINGENS SÄKERHET KAN ENDAST GARANTERAS OM DESSA ANVISNINGAR RESPEKTERAS I DETALJ. SPARA DÄRFÖR DESSA ANVISNINGAR FÖR FRAMTIDA KONSULTATION.

RU ВНИМАНИЕ:

МЫ ГАРАНТИРУЕМ БЕЗОПАСНУЮ ЭКСПЛУАТАЦИЮ ИЗДЕЛИЯ ТОЛЬКО ПРИ СОБЛЮДЕНИИ СЛЕДУЮЩИХ ИНСТРУКЦИЙ; С ЭТОЙ ЦЕЛЬЮ НЕОБХОДИМО СОХРАНИТЬ ДАННУЮ БРОШЮРУ.

ZH 警告

为确保该装置安全，请遵守操作指示；并于安全场所放置。

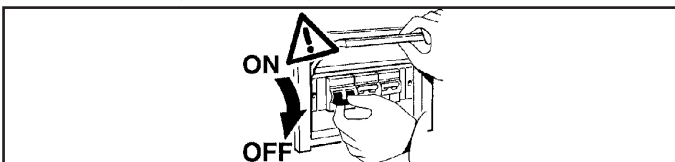

IT N.B.: DURANTE L'INSTALLAZIONE DEL SISTEMA RISPETTARE SCRUPOLOSAMENTE LE NORME IMPIANTISTICHE VIGENTI.

EN N.B.: WHEN INSTALLING THE SYSTEM, STRICTLY COMPLY WITH ALL REGULATIONS ON INSTALLATION IN FORCE.

FR N.B.: LORS DE L'INSTALLATION DU SYSTÈME VEUILLEZ RESPECTER RIGOREUSEMENT LES NORMES EN VIGUEUR EN LA MATIÈRE.

DE NB: BEACHTEN SIE BEI DER INSTALLATION DES SYSTEMS GEWISSENHAFT DIE GÜLTIGEN BESTIMMUNGEN BEZÜGLICH DER ANLAGENTECHNIK.

NL N.B.: BIJ HET INSTALLEREN VAN HET SYSTEEM MOET U DE GELDENDE INSTALLATIENORMEN STRIKT NALEVEN.

ES N.B.: DURANTE LA INSTALACIÓN DEL SISTEMA RESPETAR E SCRUPULOSAMENTE LAS NORMAS DE INSTALACIÓN VIGENTES.

DA N.B.: UNDER INSTALLATION AF SYSTEMET SKAL MAN NØJE OVERHOLDE DE GÆLDENDE REGLER FOR DISSE ANLÆG.

NO N.B.: VED INSTALLASJON AV SYSTEMET SKAL ALLE FORSKRIFTER OM INSTALLASJON SOM GJELDER FØLGES STRENGT.

SV OBS! UNDER INSTALLATIONEN AV SYSTEMET SKA INSTALLATIONSFÖRESKRIFTERNA RESPEKTERAS I DETALJ.

RU ПРИМЕЧАНИЕ: В ПРОЦЕССЕ МОНТАЖА СИСТЕМЫ СТРОГО СОБЛЮДАЙТЕ НАЦИОНАЛЬНЫЕ ДЕЙСТВУЮЩИЕ НОРМАТИВЫ ПО ЭЛЕКТРОПРОВОДКЕ.

ZH 注意：在安装系统时请遵守设备的安装规定。

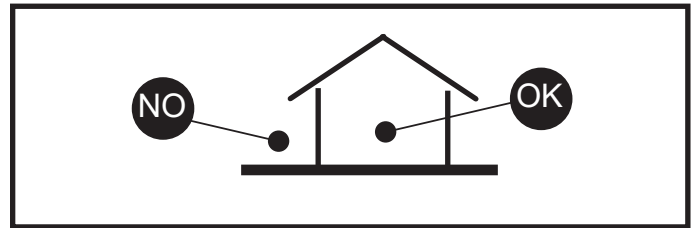

	MINIMAL VERSION	FRAME VERSION
 art. PD27 - PD28	 art. PD27 www.iguzzini.com/PD27	 art. PD28 www.iguzzini.com/PD28
 art. PD29 - PD30	 art. PD29 www.iguzzini.com/PD29	 art. PD30 www.iguzzini.com/PD30
 art. PD31 - PD32	 art. PD31 www.iguzzini.com/PD31	 art. PD32 www.iguzzini.com/PD32

IT Scansionare il codice QR o visitare www.iguzzini.com per ulteriore documentazione tecnica.

EN Scan the QR Code or visit www.iguzzini.com for more technical documentation.

FR Numériser le code QR ou consulter www.iguzzini.com pour davantage de documentation technique.

DE QR-Code scannen oder www.iguzzini.com für weitere technische Unterlagen aufrufen.

NL Escanear el código QR o visitar la página www.iguzzini.com para obtener más documentación técnica.

ES Scan de QR-code of bezoek www.iguzzini.com voor meer technische documentatie.

DA Scan QR-koden eller gå til www.iguzzini.com for yderligere teknisk dokumentation.

NO Skann QR-koden eller besøk www.iguzzini.com for mer teknisk dokumentasjon.

SV Skanna QR-koden eller gå till www.iguzzini.com för ytterligare teknisk dokumentation.

RU Сканируйте QR-код или обратитесь к www.iguzzini.com за дополнительной технической документацией.

ZH 扫描二维码或浏览网站 www.iguzzini.com 获取更多的技术文档。

IT Per le posizioni di installazione, attenersi a quelle illustrate, eventualmente contattare la iGuzzini.

EN All installation positions must comply with those illustrated. In the event of any doubt, contact iGuzzini.

FR Pour les positions d'installation, se conformer aux positions illustrées; contacter la société iGuzzini en cas de nécessité

DE Für die Einbaupositionen die Abbildungen beachten. Eventuell iGuzzini kontaktieren.

NL Houd u voor de installatieposities aan degene die zijn weergegeven. Neem eventueel contact op met iGuzzini

ES Respetar las posiciones de instalación ilustradas y, en caso de duda, contactar con iGuzzini

DA For installationspositioner skal man holde sig til de viste, og eventuelt kontakte iGuzzini

NO For installasjonsplasseringene henviser vi til illustrasjonene, eller ta eventuelt kontakt med iGuzzini

SV Följ de angivna positionerna för installationen. Kontakta vid behov iGuzzini

RU При выборе положения для монтажа следует обратиться к проиллюстрированным либо обратиться в компанию iGuzzini

ZH 安装位置请参考图示，必要时也可联系iGuzzini

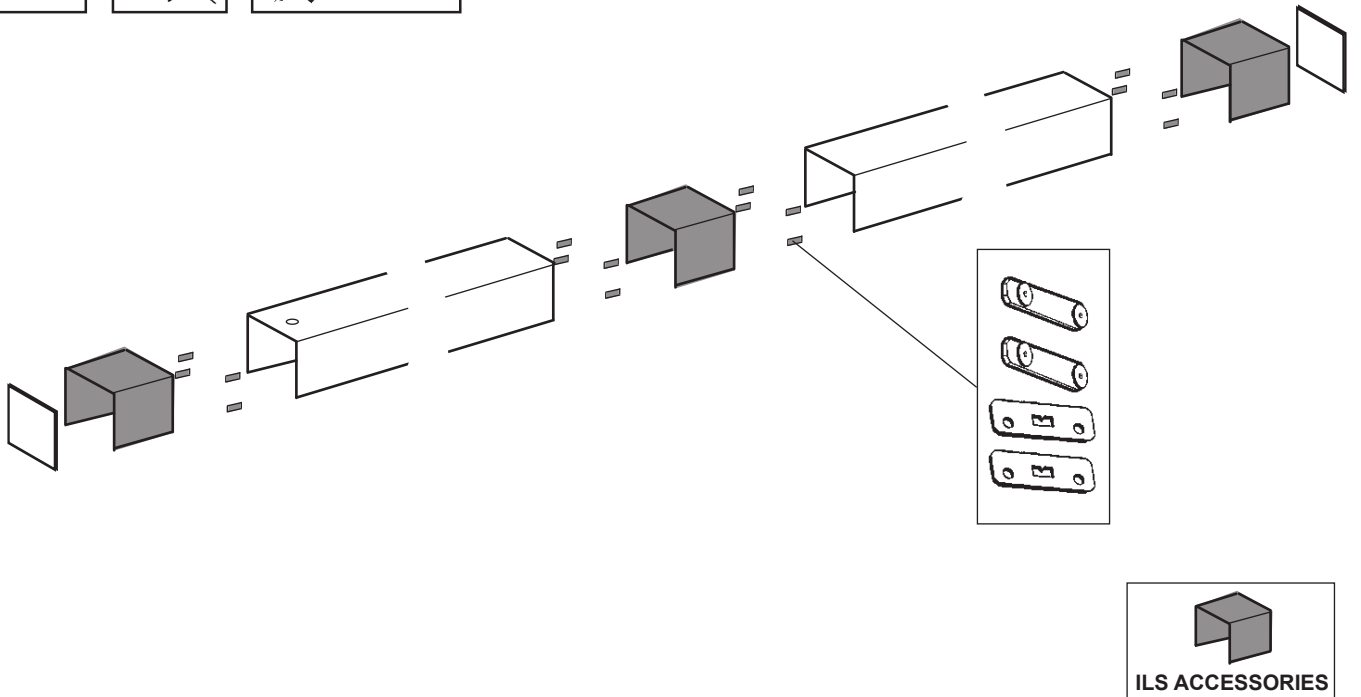
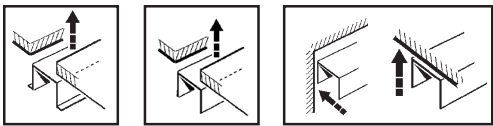
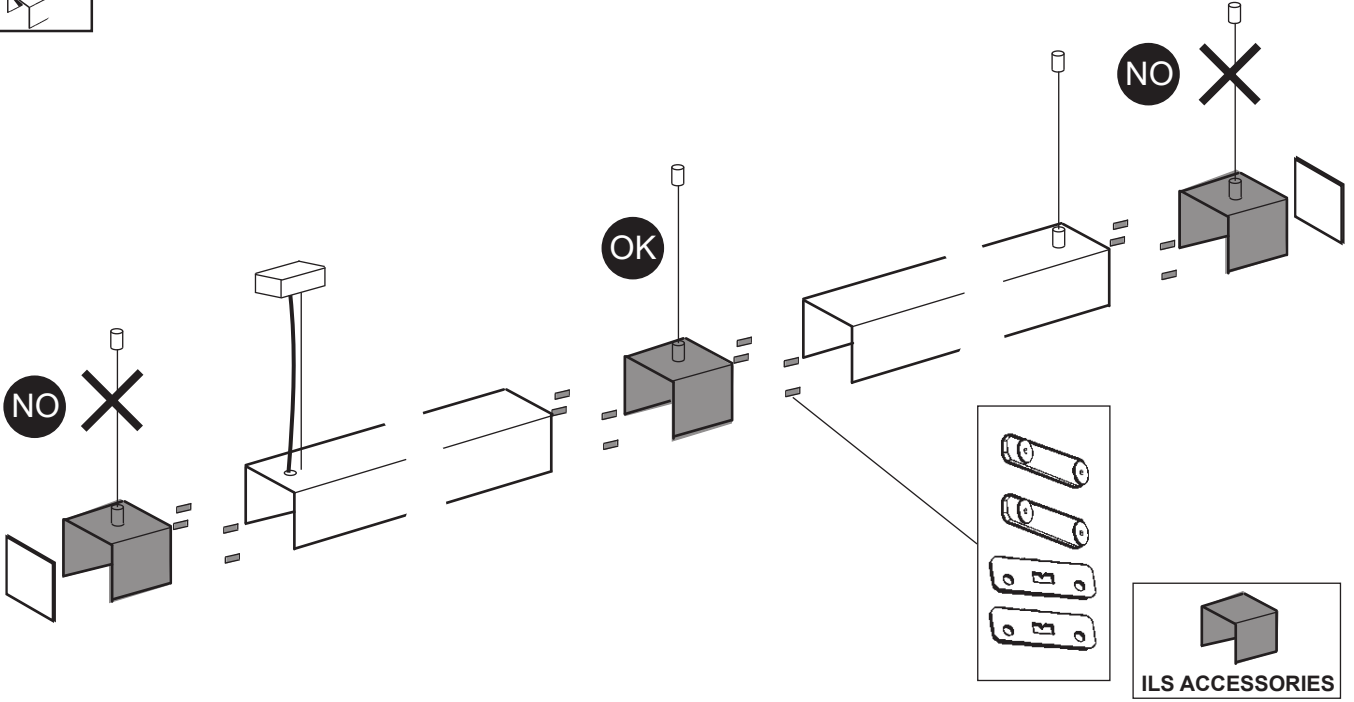
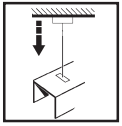

SENSORS	MODULS	
	MINIMAL Art.	FRAME Art.
DALI-2	PD27	PD28
ORGANIC RESPONSE	PD29	PD30
BLE	PD31	PD32
BLIND MODULE	PD35	PD36

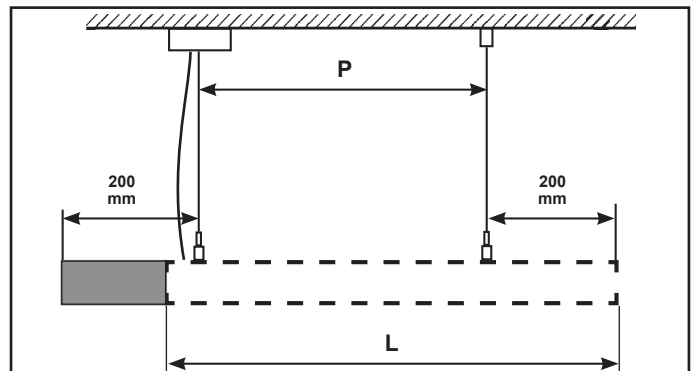
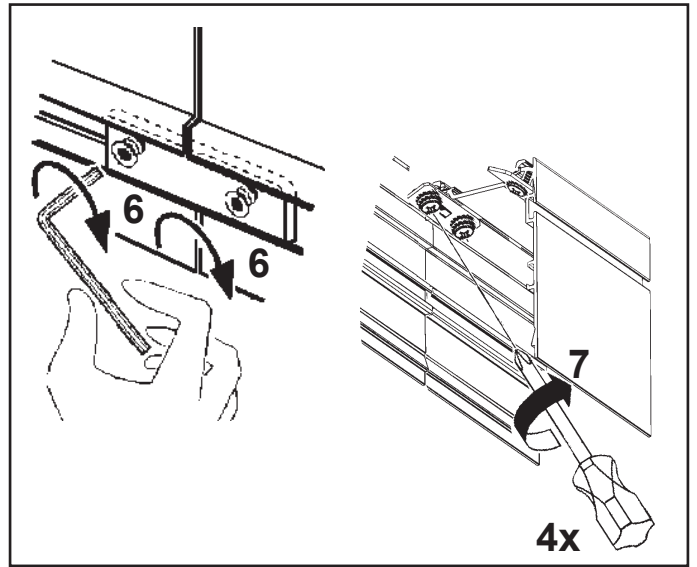
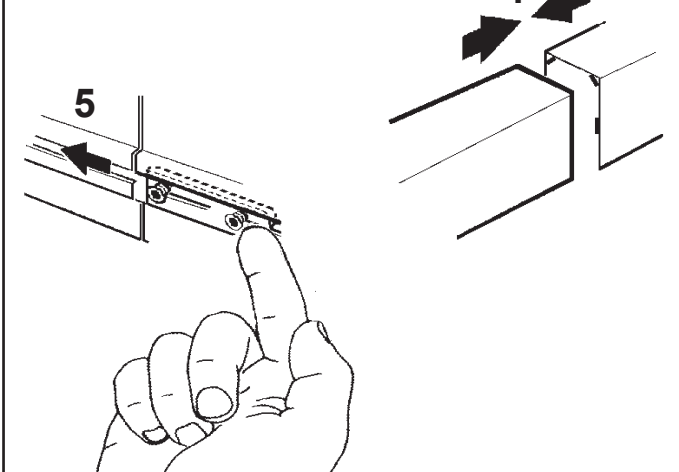
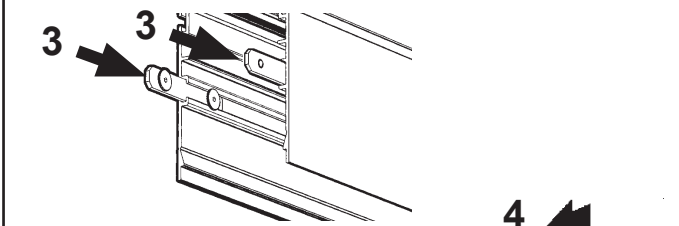
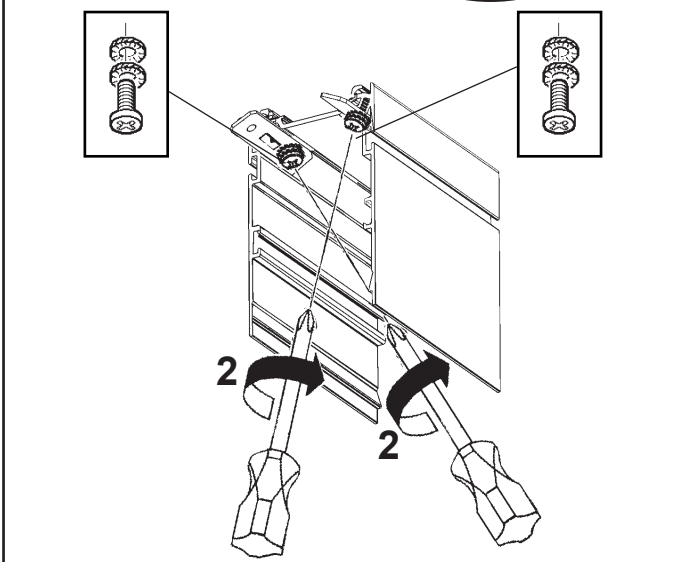
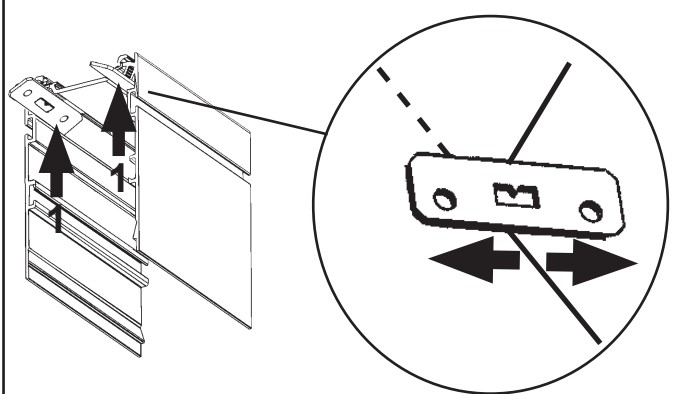
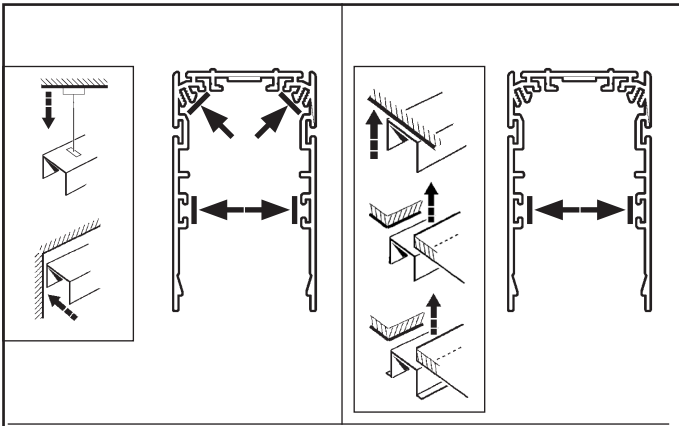

L	P
1192	942
2384	2134

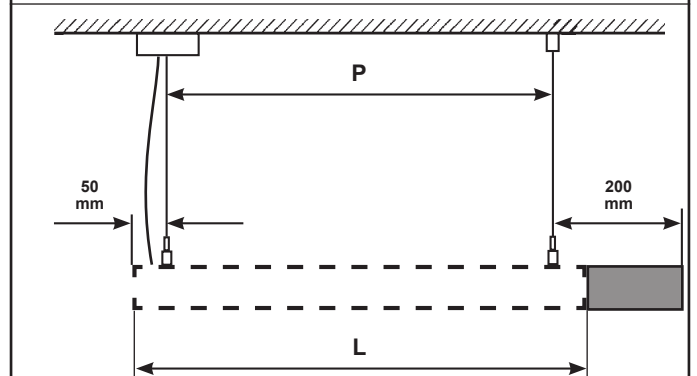

L	P
1192	1092
2384	2284

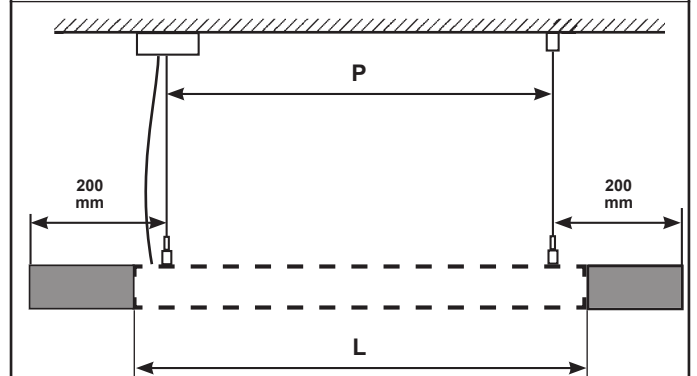

L	P
1192	1092
2384	2284

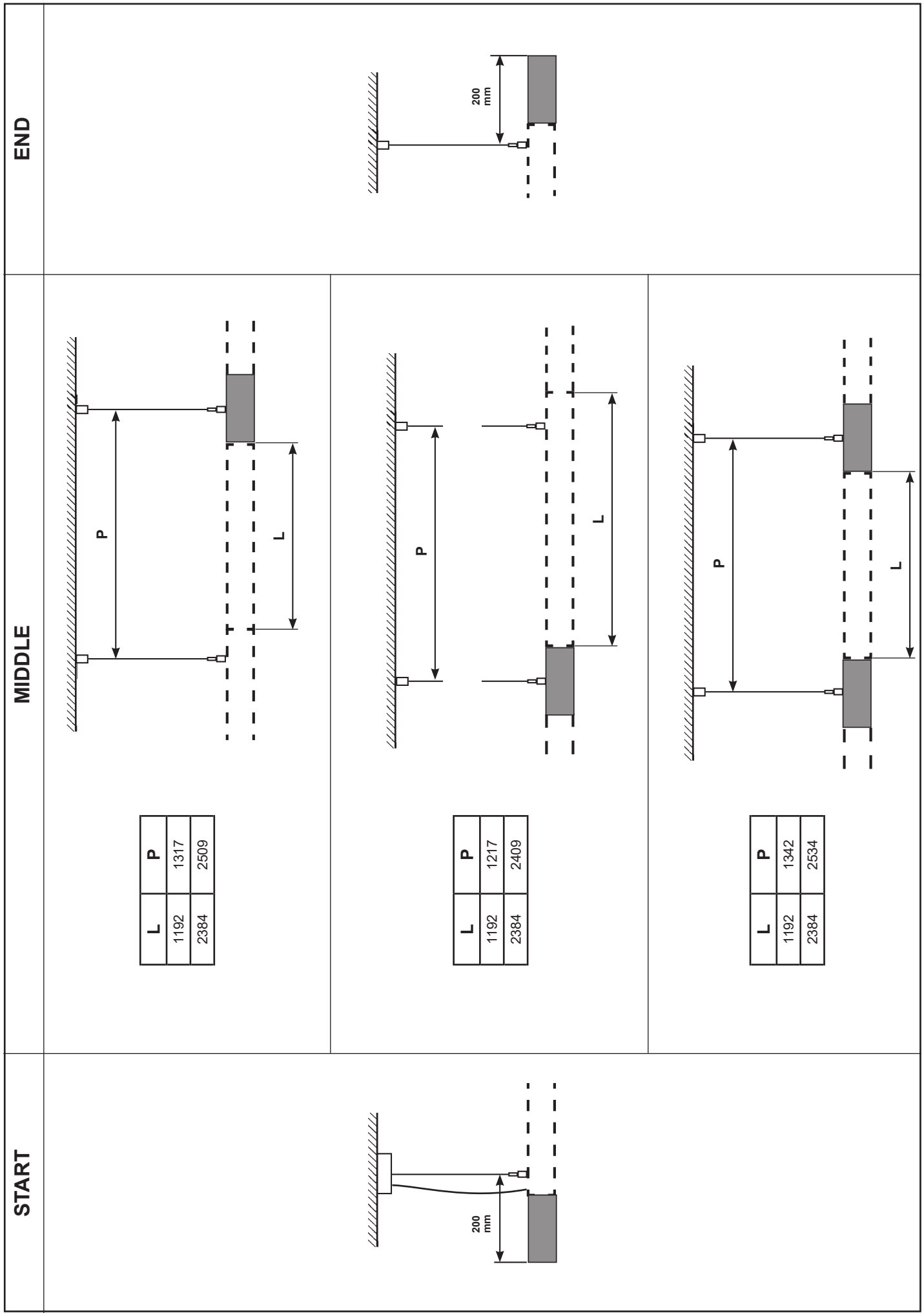

L	P
1192	1317
2384	2509

L	P
1192	1217
2384	2409

L	P
1192	1342
2384	2534

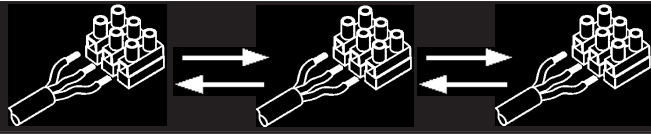

	CARICO DALI / DALI LOAD CHARGE DALI (COURANT MAXI ADMISSIBLE) DALI-LAST DALI VERMOGEN CARGA DALI DALI STRØMSTYRKE BELASTNING FOR "DALI" DALI-BELASTNING МАКС. ТОК СИСТЕМЫ DALI С РЕГУЛЯЦИЕЙ ИНТЕНСИВНОСТИ СВЕТА DALI 智能调光系统允许的最大电流	INDIRIZZI DALI DALI ADDRESSES ADRESSES DALI DALI-ADRESSEN DALI-ADRESSEN DIRECCIONES DALI DALI ADDRESSER ADRESSER TIL "DALI" DALI-ADRESSER ЛОГИЧЕСКИЕ АДРЕСА СИСТЕМЫ DALI DALI 智能调光系统计算机指定控制参数
PD27 - PD28	1 (9 mA)	1
PD29 - PD30	/	/
PD31 - PD32	/	/
PD35 - PD36	/	/

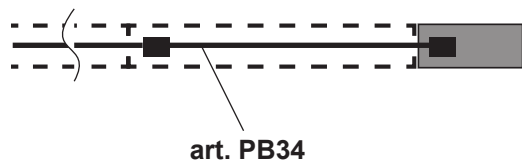
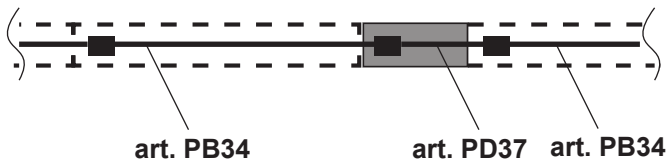
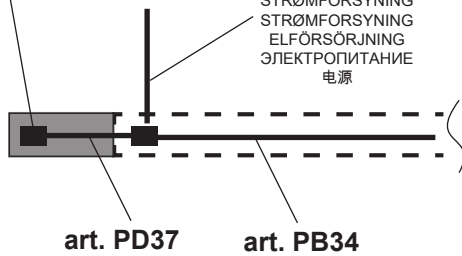
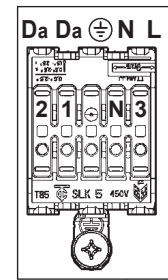
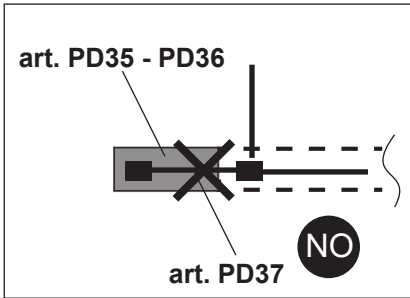

art. PB34 - PD37 CABLES

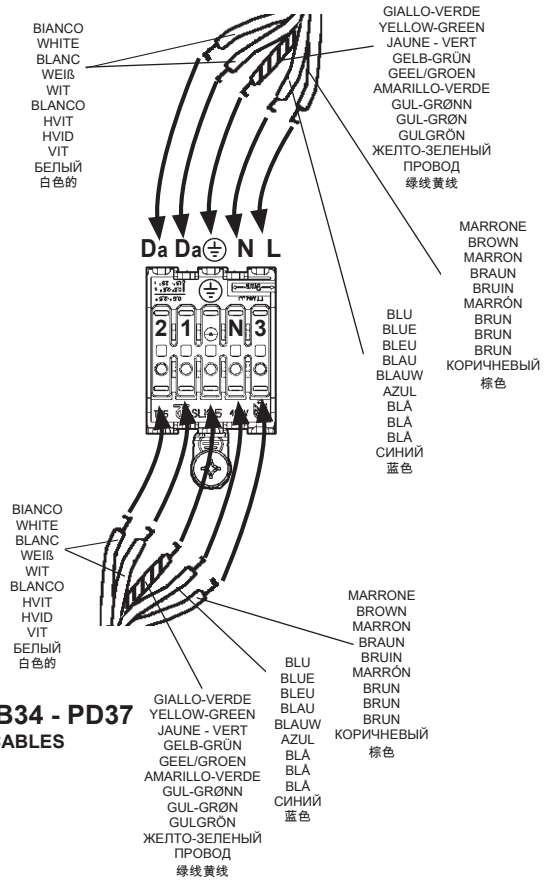

art. PB34 - PD37 CABLES

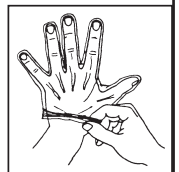
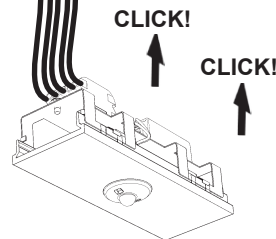
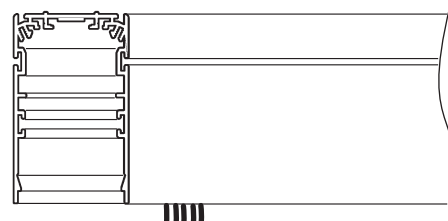

- IT Tra i conduttori di alimentazione e quelli di controllo è garantito un isolamento fondamentale.
- EN Insulation is guaranteed between the power supply wires and the control wires basic.
- FR Entre les conducteurs d'alimentation et les conducteurs de commande, une isolation est garantie fondamentale.
- DE Zwischen den Versorgungs- und Steuerungsleitern ist eine Isolierung Basis gewährleistet.
- NL Tussen de geleiders van de voeding en de controle wordt een isolatie gewaarborgd fundamenteel.
- ES Entre los conductores de alimentación y los de control está garantizado el aislamiento fundamental.
- DA Der er garanteret en isolering grundlæggende imellem forsyningslederne og styrelederne.
- NO Det garanteres en isolering fundamental mellom strømlederne og kontrolllederne.
- SV Det garanteras isolering grundläggande mellan matningsledare och kontrollkablar.
- RU Гарантируется развязка цепей питания и управления фундаментальная.
- ZH 电源线和控制线之间有绝缘保证基本。

