

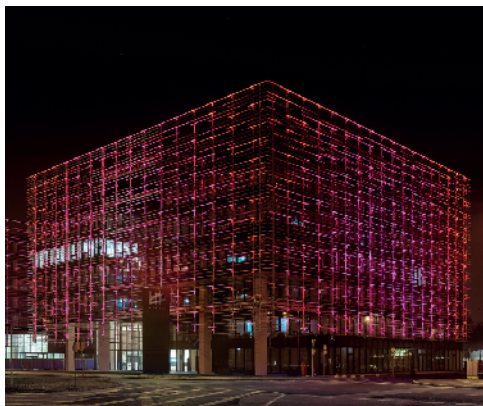

Surface mounted luminaire that emits a light blade without any unwanted dispersion. Design by Dean Skira.

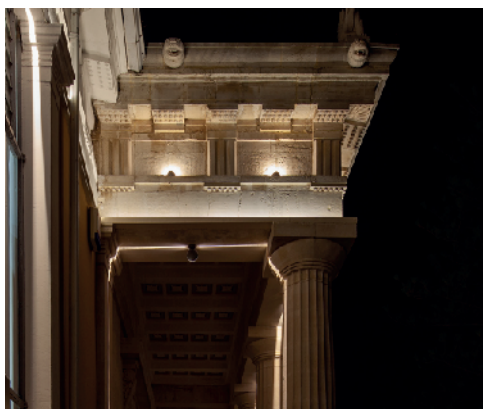

Luminaire characteristic:	Power input: 7.2W (system wattage) Lumens: 31lm or 144lm (for 3000K, 80CRI) Luminaire efficacy: Up to 20lm/W
Source:	White LED (LM-80), 3000K: 80CRI,
Lumen maintenance:	80% of initial lumens at 50 000 hours (L80) (LM-79).
Optic:	360° radial effect and light blade.
Material:	Body: Die-cast aluminum Diffuser: PMMA lens Hardware: Stainless steel screws
Mounting:	Wall or ceiling mounted, installs on standard 4" octagonal junction box. Floor mounting in dry location only (interior).
Electrical:	Integral high efficiency LED driver rated at 50 000 hours, 120-277V.
Finish:	White (RAL9016), black, rust brown or gray (RAL9007) painted finish with a high level of weather and UV resistance. The semi-gloss finish coating is electrostatically applied, durable acrylic enamel baked at high temperatures for superior color retentive finish.
Operating temperature:	BO -30°C to 50°C (-22°F to 122°F)
Weight:	1.1lb (0.5kg)
Warranty:	5 year limited warranty.
Ratings:	IP66, IK07
Certification:	cULus listed for wet location.



ORDERING INFO



PRODUCT CODE

--	--	--	--	--	--	--	--

MODEL	SIZE	OUTPUT	MOUNTING	LED	OPTIC	VOLTAGE	FINISH
ITRC Trick	S Small	BO Base output	JB Surface mounted junction box	830 3000K, 80CRI	BL360 Blade 360° LL Blade effect	UNV 120-277V	01 White 02 Black 15 Gray F5 Rust brown

DIMENSIONS

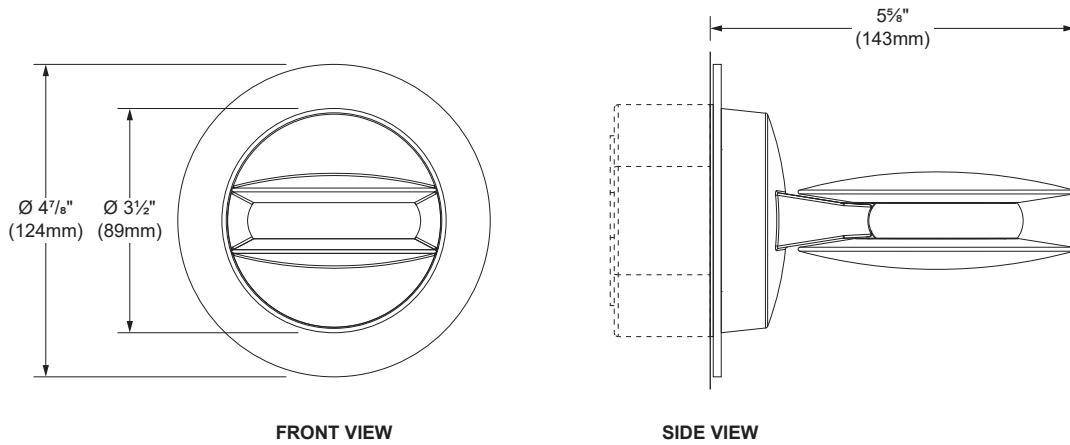

PHOTOMETRIC DATA

BL360 - 360° BLADE EFFECT



CCT (K)	CRI	OUTPUT	LOAD (W)	OPTIC	LUMENS (lm)	EFFICACY (lm / W)	MAX CANDELA (cd)	MODEL
3000K	80	BO	7.2W	360° blade effect	144	20	467	ITRC-S-BO-XX-830-BL360

BO 360° blade effect (3000K, 80CRI)

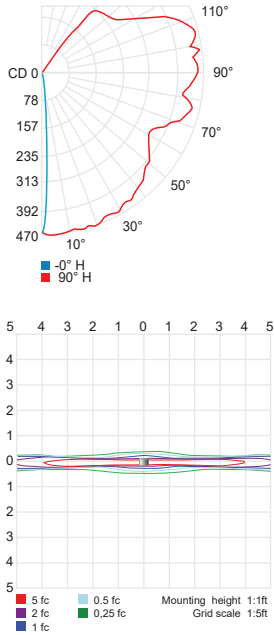

360° BLADE EFFECT

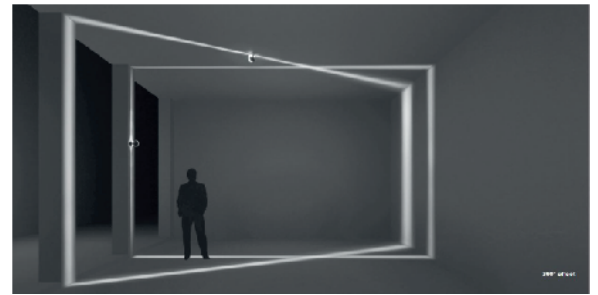

LL - BLADE EFFECT



CCT (K)	CRI	OUTPUT	LOAD (W)	OPTIC	LUMENS (lm)	EFFICACY (lm / W)	MAX CANDELA (cd)	MODEL
3000K	80	BO	7.2W	Blade effect	31	4	271	ITRC-S-BO-XX-830-LL

BO blade effect (3000K, 80CRI)

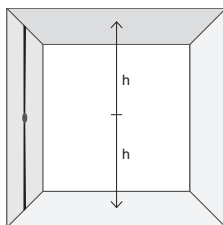
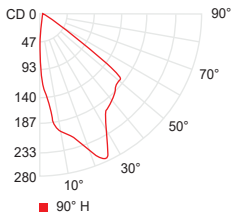

Distance (h)	Blade width	Illuminance
3.2'	3.5"	33.45 fc
6.5'	7"	8.36 fc
9.8'	10.6"	3.72 fc



LL- LIGHT BLADE EFFECT

