

# iGuzzini

## EASY LED EASY SPACE

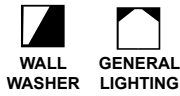

Ø □  
105/163/225  
mm

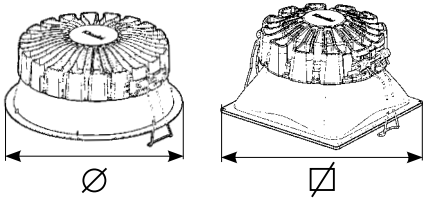

- IT Consultare per istruzioni di installazioni aggiuntive.  
EN Consult relevant sources for instructions regarding additional installations.  
FR Consulter pour obtenir des instructions d'installation supplémentaires.  
DE Nachlesen, um weitere Installationsanweisungen zu erhalten.  
ES Consultar para conocer las instrucciones de instalación adicionales.  
NL Raadpleeg de aanvullende installatie-instructies.  
DA Se for yderligere instruktioner til installation.  
NO Konsultere for instruksjoner om ekstra installasjoner.  
SV Konsultera för ytterligare installationsanvisningar.  
RU Обратитесь к дополнительным инструкциям по установке.  
ZH 请参考附加安装说明

استشر للحصول على إرشادات التركيب الإضافية.



### IT Attenzione:

La sicurezza dell'apparecchio e' garantita solo con l'uso appropriato delle seguenti istruzioni; pertanto e' necessario conservarle.

### EN Warning:

The safety of this fixture is guaranteed only if you comply with these instructions; remember to conserve in a safe place.

### FR Attention:

La sécurité de l'appareil n'est garantie qu'en cas d'utilisation correcte des instructions suivantes; il faut par conséquent les conserver.

### DE Achtung:

Die sicherheit des gerätes wird nur durch sachgemässe befolgung nachstehender anweisungen gewährleistet; ihre aufbewahrung ist deshalb sehr wichtig.

### NL Opgelet:

De veiligheid van di toestel is slechts dan gegarandeerd als indien de volgende instructies strikt worden toegepast; daarom moet men ze ook bewaren.

### ES Atencion:

La seguridad del aparato se garantiza solo cumpliendo cuidadosamente las siguientes instrucciones; por ello, es necesario conservarlas.

### DA Bemærk:

Sikkerheden ved brug af armaturet kan kun garanteres, hvis disse anvisninger følges; sørg derfor for at gemme dem.

### NO Advarsel:

Sikkerheten til dette apparatet garanteres kun hvis du overholder disse instruksjonene; husk å oppbevare dem på et trygt sted.

### SV Observera:

Utrustningens säkerhet kan endast garanteras om dessa anvisningar respekteras i detalj. Spara därför dessa anvisningar för framtida konsultation.

### RU Внимание:

Мы гарантируем безопасную эксплуатацию изделия только при соблюдении следующих инструкций; с этой целью необходимо сохранить данную брошюру.

### ZH 警告:

为确保该装置安全，请遵守操作指示；并于安全场所放置。

تحذير:

لا يمكن ضمان سلامة هذا الجهاز إلا إذا التزمت بهذه التعليمات. يجب حفظها في مكان آمن.

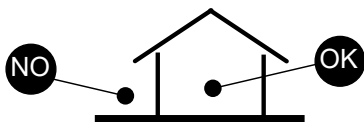

- IT N.B.: Durante l'installazione del sistema rispettare scrupolosamente le norme impiantistiche vigenti.  
EN N.B.: When installing the system, strictly comply with all regulations on installation in force.  
FR N.B.: Lors de l'installation du système veuillez respecter rigoureusement les normes en vigueur en la matière.  
DE N.B.: Beachten sie bei der installation des systems gewissenhaft die gültigen bestimmungen bezüglich der anlagentechnik.  
NL N.B.: Bij het installeren van het systeem moet u de gelden de installatienormen strikt naleven.  
ES N.B.: Durante la instalación del sistema respetar e scrupulosamente las normas de instalación vigentes.  
DA N.B.: Under installation af systemet skal man nøje overholde de gældende regler for disse anlæg.  
NO N.B.: Ved installasjon av systemet skal alle forskrifter om installasjon som gjelder følges strengt.  
SV OBS.: Under installationen av systemet ska installationsföreskrifterna respekteras i detalj.  
RU примечание: в процессе монтажа системы строго соблюдайте национальные действующие нормативы по электропроводке.  
ZH 注意: 在安装系统时请遵守设备的安装规定。  
AR ملاحظة: أثناء تركيب النظام يجب التقيد بحرص بالنظم السائدة المتعلقة بالشبكة الكهربائية.

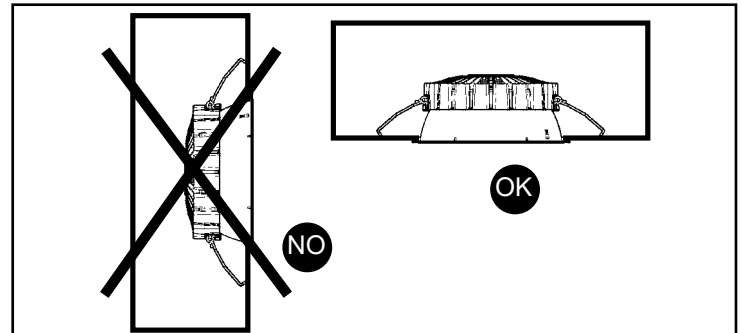

- IT Per le posizioni di installazione, attenersi a quelle illustrate, eventualmente contattare la iGuzzini.  
EN All installation positions must comply with those illustrated. In the event of any doubt, contact iGuzzini.  
FR Pour les positions d'installation, se conformer aux positions illustrées; contacter la société iGuzzini en cas de nécessité.  
DE Für die Einbaupositionen die Abbildungen beachten. Eventuell iGuzzini kontaktieren.  
NL Houd u voor de installatieposities aan degene die zijn weergegeven. Neem eventueel contact op met iGuzzini.  
ES Respetar las posiciones de instalación ilustradas y, en caso de duda, contactar con iGuzzini.  
DA For installationspositioner skal man holde sig til de viste, og eventuelt kontakte iGuzzini.  
NO For installasjonsplasseringene henviser vi til illustrasjonene, eller ta eventuelt kontakt med iGuzzini.  
SV Följ de angivna positionerna för installationen. Kontakta vid behov iGuzzini.  
RU При выборе положения для монтажа следует обратиться к проиллюстрированному либо обратиться в компанию iGuzzini.  
ZH 安装位置请参考图示，必要时也可联系iGuzzini。

في ما يتعلق بأوضاع التركيب، التزم بما هو موضح ومحدد، إذا دعت الضرورة اتصل ب iGuzzini

Ø (mm)	X max (mm)	Y max (mm)
96	850	900
153	950	1050
212	1050	1150



IT N.B.: Apparecchi non idonei ad essere coperti di materiale termicamente isolante  
 EN N.B.: Fixtures not suitable to be covered in thermally-insulating material.  
 FR N.B.: Appareils ne pouvant pas être couverts de matériau d'isolation thermique  
 DE N.B.: Geräte nicht geeignet, um mit wärmeisolierendem Material abgedeckt zu werden  
 NL N.B.: Deze apparaten zijn niet geschikt om te worden bedekt met thermisch isolerend materiaal  
 ES NOTA: Aparatos no aptos para ser cubiertos de material térmicamente aislante  
 DA N.B.: Armaturerne må ikke dækkes af varmeisolerende materiale.  
 NO N.B.: Apparatene passer ikke til å dekkes av termoisolerende materialer.  
 SV OBS! Utrustningen får inte täckas över med värmeisolerande material  
 RU Внимание: Приборы непригодны для покрытия термоизоляционным материалом.  
 ZH 灯具不适宜用隔热材料加以覆盖。  
 AR ملاحظة: اجهزة غير قابلة للتغطية مواد عازلة حرارياً.

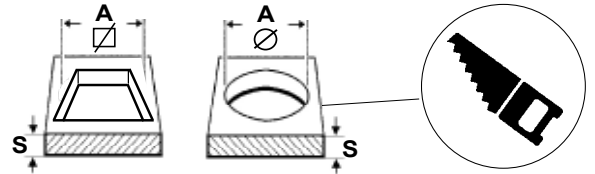
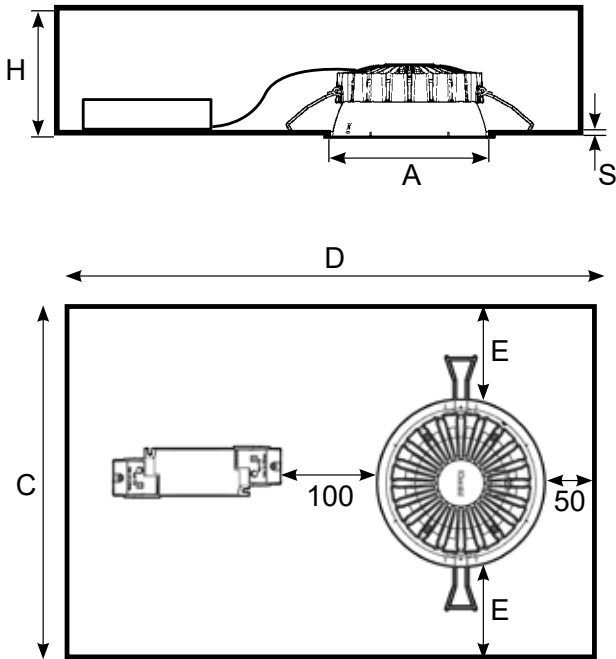

ART.		A <sup>+2</sup> <sub>0</sub> mm	D mm	C mm	E mm	H mm	S mm
∅ 105	QF49 - QF50 - QF51 - QF52 - QF53 - QG17 - QG18 QG19 - QG20 - QG21 - QV75 - QV76 - QV77 - QV78 QV79 - R496 - R497 - R498 - R499 - R500 - R521 - R522 RL56 - RL58 - RM36 - RL86 - RL87 - RM37 - RL96 RL97 - RL98 - RL99 - RM39 - RM26 - RM27 - RM38 RI27 - RI28 - RI29 - RI30 - RI31 - RI32 - RI33 - PQ06 PQ07 - PQ08 - PQ09 - PQ10 - PQ11 - PQ12 - PQ13 PQ14 - PQ15 - PQ16 - PR36 - PR37 - PR38 - PR39 PR40 - PR41 - PR42 - PR43 - PR44 - PR45 - PR46 PQ17 - PQ18 - PQ19 - PQ20 - PQ21 - PQ22 - PQ23 PW60 - PW61 - PW62	∅ 96 ∅ 96	450	230	60	75	
	QF54 - QF55 - QF56 - QF57 - QF58 - QF59 - QF60 QF61 - QF62 - QF63 - QG22 - QG23 - QG24 - QG25 QG26 - QG27 - QG28 - QG29 - QG30 - QG31 - QW07 QW08 - QW09 - QW10 - QW11 - QW12 - QW13 - QW14 QW15 - QW16 - QW17 - QW18 - R501 - R502 - R503 R504 - R505 - R506 - R507 - R508 - R509 - R510 - R448 R449 - R450 - R451 - R452 - R453 - R468 - R469 - R470 R471 - R472 - R473 - PQ58 - PQ59 - PQ60 - PQ63 - PQ64 PQ65 - PQ42 - PQ43 - PQ44 - PQ45 - PQ46 - PQ47 PQ52 - PQ53 - PQ54 - PQ55 - PQ56 - PQ57 - PQ66 PQ67 - PQ68 - PQ69 - PQ70 - PQ71 - PQ76 - PQ77 PQ78 - PQ79 - PW63 - PW64 - PW65 - PW66 - PW67 PW68 - PW69 - PW70 - PW71	∅ 153 ∅ 153	510	350	90	85	
∅ 163	QF80 - QF81 - QF82 - QF83 - QF84 - QF85 - QF86 QF87 - QF88 - QF89 - QF90 - QF91 - QG13 - QG14 QV80 - QV81 - QV82 - QV83 - QV84 - QV85 - QV86 QV87 - QV88 - QV89 - R758 - R759 - R760 - R761 RL60 - RL61 - RL62 - RL63 - RL70 - RL71 - RL72 - RL73 RL80 - RL81 - RL88 - RL89 - RL90 - RL91 - RM00 RM01 - RM02 - RM03 - RM10 - RM11 - RM12 - RM13 RM20 - RM21 - RM28 - RM29 - RM30 - RM31 - RM40 RM41 - RM42 - RM43 - RM50 - RM51 - RI34 - RI35 RI36 - RI37 - RI38 - RI39 - RI40 - RI41 - RI42 - RI43 RI44 - RI45 - RI46 - RI47 - RI68 - RI69 - RI70 - RI71 RI72 - RI73 - PQ24 - PQ25 - PQ26 - PQ27 - PQ28 PQ29 - PQ30 - PQ31 - PQ32 - PQ33 - PQ34 - PQ35 PQ36 - PQ37 - PQ38 - PQ39 - PQ40 - PQ41 - PQ61 PQ62 - PR47 - PR48 - PR49 - PR50 - PR51 - PR52 PR53 - PR54 - PR55 - PR56 - PR57 - PR58 - PR59 PR60 - PR61 - PR62 - PR63 - PR64 - PR65 - PR66 PR67 - PR68 - PR69 - PR70 - PS29 - PS30 - PQ48 PQ49 - PQ50 - PQ51 - PQ72 - PQ73 - PQ74 - PQ75	∅ 153	510	350	90	100	
	QF67 - QF68 - QF69 - QF70 - QF71 - QF72 - QF73 QF74 - QF75 - QF76 - QF96 - QF97 - QF98 - QF99 QG01 - QG02 - QG03 - QG04 - QG05 - QG06 - QG07 QG08 - QG15 - QG16 - QG32 - QG33 - QG34 - QG35 QG36 - QG37 - QG38 - QG39 - QG40 - QG41 - QV93 QV94 - QV95 - QV96 - QV97 - QV98 - QV99 - QW00 QW01 - QW03 - QW23 - QW24 - QW25 - QW26 - QW27 QW28 - QW29 - QW30 - QW31 - QW32 - QW33 - QW34 R511 - R512 - R513 - R514 - R515 - R516 - R517 - R518 R520 - R478 - R479 - R480 - R481 - R482 - R483 - R762 R763 - R764 - R765 - R458 - R459 - R460 - R461 - R462 R463 - RL65 - RL66 - RL67 - RL68 - RL75 - RL76 - RL77 RL78 - RL83 - RL84 - RL92 - RL93 - RL94 - RL95 - RM05 RM06 - RM07 - RM08 - RM15 - RM16 - RM17 - RM18 RM23 - RM24 - RM32 - RM33 - RM34 - RM35 - RM45 RM46 - RM47 - RM48 - RM53 - RM54 - RI51 - RI52 - RI53 RI54 - RI55 - RI56 - RI57 - RI58 - RI59 - RI60 - RI61 RI62 - RI63 - RI64 - RI78 - RI79 - RI80 - RI81 - RI82 RI83 - PQ80 - PQ81 - PQ82 - PQ83 - PQ84 - PQ85 PQ86 - PQ87 - PQ88 - PQ89 - PQ90 - PQ91 - PQ92 PQ93 - PQ94 - PQ95 - PQ96 - PQ97 - PR14 - PR15 - PR16 PR17 - PR18 - PR19 - PR20 - PR21 - PR71 - PR72 - PR73 PR74 - PR75 - PR76 - PR77 - PR78 - PR79 - PR80 - PR81 PR82 - PR83 - PR84 - PR85 - PR86 - PR87 - PR88 - PR89 PR90 - PR91 - PR92 - PR93 - PR94 - PR95 - PR96 - PQ98 PQ99 - PR00 - PR01 - PR02 - PR03 - PR04 - PR05 - PR06 PR07 - PR08 - PR09 - PR10 - PR11 - PR12 - PR13 - PR22 PR23 - PR24 - PR25 - PR26 - PR27 - PR28 - PR29 - PR30 PR31 - PR32 - PR33 - PR34 - PR35 - PW72 - PW73 PW74 - PW75 - PW76 - PW77	∅ 212 ∅ 212	570	370	75	100	

DALI  
ELE

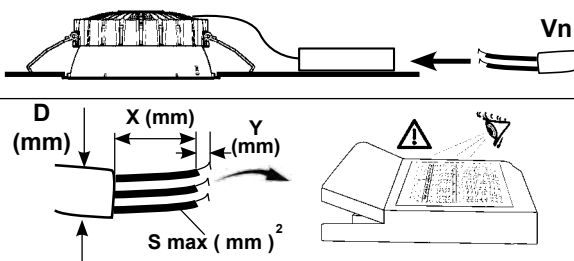

	S <sup>2</sup> mm	Y mm	X mm	D mm
Osram OTI FIT CS / IT FIT CS-CSI	0,75 - 1,5	7 - 8		
Tridonic advanced		8,5 - 9,5		
Philips Titanium mini DALI	0,5 - 1,5	8,5 - 9,5	30	/
Osram OTI DALI		8 - 9		
TCI Pro Flat 22	0,75 - 1,5	8,5 - 9,5		
Osram OTI FIT NFC / IT FIT CS-CSI		7 - 8		
TRIDONIC LC o4a NF	0,5 - 2,5	10,5	20	6 - 12,2
PHILIPS XITANIUM MINI	0,5 - 2,5	10 - 11	20	/

- IT** Nel caso di prodotti in classe seconda, non collegare l'eventuale terra di sicurezza presente sull'alimentatore.
- EN** In the case of second-class products, do not connect any safety grounding to the power supply.
- FR** En cas de produits en deuxième classe, ne pas brancher l'éventuelle terre de sécurité présente sur le ballast.
- DE** Im Fall von Produkten zweiter Klasse die am Vorschaltgerät eventuell befindliche sichere Erdung nicht anschließen.
- NL** Bij een product uit de secundaire klasse moet de eventuele aardedraad in het VSA niet worden aangesloten.
- ES** En los productos de segunda clase, no conectar la toma de tierra de seguridad incluida en el alimentador.
- DA** Ved produkter i anden klasse må man ikke tilslutte en evt. Sikkerhedsjordforbindelse, som findes på forkoblingsenheden.
- NO** I tilfelle av produkter i andre klasse skal du ikke koble til en eventuell sikkerhetsjording på strømforsyningen.
- SV** Om produkterna ingår i kategori två ska man inte koppla in eventuell skyddsjord som finns på strömförsörjningen.
- RU** В случае использования изделий второго класса, не подключать возможное заземление, имеющееся на питателе.
- ZH** 如果属于第二类产品，请勿连接电源上的任何安全地线。

**AR** في حالة منتجات الفئة الثانية، لا تقم بتوصيل سلك تأريض السلامة إذا كان موجوداً على وحدة التغذية بالطاقة.



- IT** I dispositivi con cablaggio digitale possono essere dimmerati con dispositivi DALI o con pulsante normalmente aperto (N.O.) da collegare come da schema.
- EN** Devices with digital control gear may be dimmed using DALI devices or a normally-open button (N.O.) to be connected as shown in the diagram.
- FR** Les articles à câblage numérique peuvent fonctionner avec des variateurs à dispositifs DALI ou à bouton poussoir normalement ouvert (N.O.) à relier conformément au schéma.
- DE** Die Geräte mit digitaler Verkabelung können mit Hilfe von DALI-Vorrichtungen oder mit Hilfe eines gemäß Schaltplan anzuschließenden Schließers (N.O.) gedimmt werden.
- NL** De producten met digitale bekabeling kunnen worden gedimd met DALI systemen of met een N.O. (normally open) knop, die moet worden aangesloten volgens schema.
- ES** Los dispositivos con cableado digital pueden regularse con dispositivos DALI o con un interruptor de botón normalmente abierto (N.O.) que se conecta según ilustrado en el esquema.
- DA** Produkter med digital kabelføring kan dæmpes med DALI-anordninger eller med kontakten, som normalt er åben (N.O.) og som skal tilsluttes, som vist.
- NO** Produkter med digitalkabler kan dimmes med DALI-anordninger eller med en normalt åpen (NO) trykkbryter som kobles som vist i koblingsskjema.
- SV** Produkter med digital kabeldragning kan förädas med dimmer. Detta kan göras med DALI-anordningarna eller med en normalt öppen kontakt (N.O.) som ska anslutas enligt schemat.
- RU** Интенсивность приборов с цифровой проводкой может регулироваться посредством устройств DALI или нормально разомкнутой кнопкой (Н.Р.), подсоединяемой согласно схеме.
- ZH** 带有数字控制装置的设备可以通过 DALI (数字化可寻址调光接口) 设备或者一个连接方式如图中所示的常开按钮 (N.O.) 进行亮度调节

يمكن أن يتم تخفيض إضاءة الأجهزة ذات الكابلات الرقمية؛ وذلك عن طريق استخدام أجهزة الإمداد بالطاقة الكهربائية «دالي» (DALI)، أو عن طريق استخدام زر يكون مفتوحاً في وضعه الطبيعي (N.O.)؛ حيث يتم التوصيل كما هو مبين في المخطط.

**AR**



**+ ART. PA09**



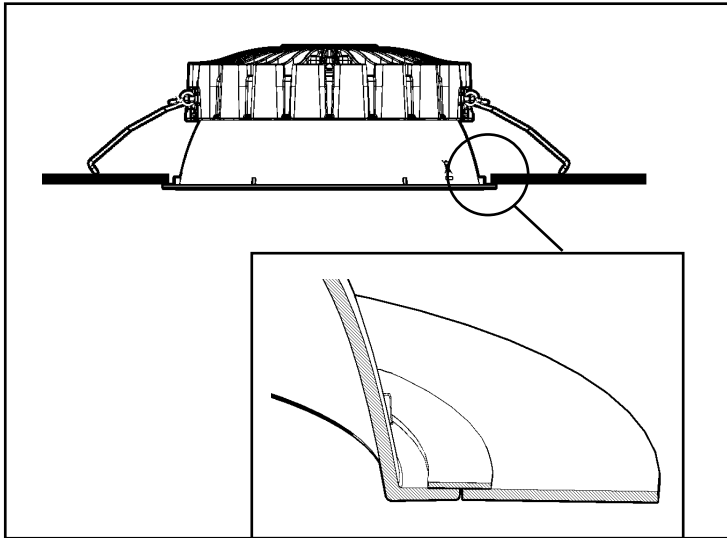

# ADDITIONAL INSTALLATION INSTRUCTIONS

IS21480/00 (29/01/2025)

## iGuzzini EASY LED EASY SPACE

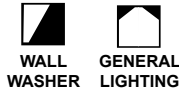

Ø  $\square$   
105/163/225  
mm

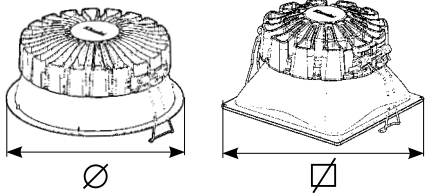

- IT** Pilotare diversi prodotti DALI tramite pulsante (es: Touch-dim, Switch-dim, Push-dim, Direct-dim, etc.) potrebbe causare dei problemi di sincronizzazione tra gli stessi. È possibile ovviare a questo problema dotandosi di dispositivi aggiuntivi. Per maggiori informazioni vi invitiamo a contattarci direttamente.
- EN** Controlling different DALI products through buttons (e.g.: Touch-dim, Switch-dim, Push-dim, Direct-dim, etc.) may lead to product synchronisation problems. This problem can be overcome by using additional devices. For further information, please contact us directly.
- FR** Piloter plusieurs produits DALI par bouton (ex : Touch-dim, Switch-dim, Push-dim, Direct-dim, etc.) pourrait causer des problèmes de synchronisation entre eux. Ce problème peut être évité en s'équipant de dispositifs supplémentaires. Pour de plus amples renseignements, veuillez nous contacter directement.
- DE** Die Steuerung verschiedener DALI-Produkte mittels Taste (z.B.: Touch-dim, Switch-dim, Push-dim, Direct-dim etc.) kann eventuell zu Synchronisierungsproblemen zwischen diesen führen. Dieses Problem lässt sich durch den Einsatz von zusätzlichen Geräten beheben. Wenn Sie weitere Informationen wünschen, setzen Sie sich bitte direkt mit uns in Verbindung.
- NL** Het besturen van verschillende DALI producten m.b.v. dezelfde knop (bv.: Touch-dim, Switch-dim, Push-dim, Direct-dim, etc.) kan synchronisatieproblemen tussen de producten opleveren. Men kan dit probleem voorkomen door extra systemen aan te sluiten. Voor verdere informatie raden we u aan direct contact met ons op te nemen.
- ES** El mando de varios productos DALI por tecla (ej: Touch-dim, Switch-dim, Push-dim, Direct-dim, etc.) podría causar problemas de sincronización entre ellos. Es posible prevenir este problema utilizando dispositivos adicionales. Para más información, contacte directamente con nosotros.
- DA** Hvis DALI-produkterne styres ved hjælp af knapperne (fx. Touch-dim, Switch-dim, Push-dim, Direct-dim osv.) kan det skabe problemer med synkronisering af samme. Dette problem kan undgås, hvis man køber ekstra enheder. For yderligere oplysninger, kontakt os direkte.
- NO** Å styre ulike DALI-produkter ved hjelp av en trykknappbryter (f.eks. touch-dim, switch-dim, push-dim, direct-dim, osv.) vil kunne føre til problemer med synkronisering mellom dem. Dette problemet kan løses ved hjelp av noen tilleggsinnretninger. Ta gjerne kontakt med oss for mer informasjon om dette.
- SV** Styrning av olika DALI-produkter med knapp (t.ex.: Touch-dim, Switch-dim, Push-dim, Direct-dim o.s.v.) kan orsaka synkroniseringsproblem mellan dessa. Detta problem kan åtgärdas med tillägsanordningar. För mer information kan du kontakta oss direkt.
- RU** Управление различными продуктами DALI с помощью кнопки (напр.: Touch-dim, Switch-dim, Push-dim, Direct-dim и пр.) может вызвать проблемы синхронизации между ними. Эту проблему можно устранить путем задействования дополнительных устройств. За получением более подробной информации просим Вас связаться с нами непосредственно.
- ZH** 通过按钮控制不同的 DALI 产品 (例如: 触摸调光、切换调光、按压调光、直接调光等) 可能会导致产品的同步问题。该问题可通过使用其他额外的装置加以克服。如需了解更多信息, 请直接与我们联系。

يمكن أن يتسبب التحكم في منتجات "دالي" المختلفة عن طريق الأزرار، (مثل الأزرار: "تنش-ديم"، "بوش-ديم"، "دايركت-ديم"، إلخ...)، في حدوث مشاكل تتعلق بعملية التزامن بين هذه الأزرار. وإن كان من الممكن تجنب مثل هذه

 <b>ART.</b>	Carico dali / dali load Charge dali (Courant maxi admissible) Dali-last Dali vermogen Carga dali Dali strømstyrke Belastning for "dali" Dali-belastning Макс. Ток системы dali с регуляцией интенсивности света DALI 智能调光系统允许的最大电流量 DALI شحنة / DALI حمل	Indirizzi dali Dali addresses Adresses dali Dali-adressen Dali adressen Direcciones dali Dali adresser Adresser til "dali" Dali-adresser Логические адреса системы dali DALI智能调光系统计算机指定 控制参数 DALI عناوين
	1	1

- IT** N.B.: Per la sostituzione del LED contattare l'azienda iGuzzini.
- EN** N.B.: For information on LED replacement please contact iGuzzini.
- FR** N.B.: Pour procéder au remplacement de la LED, adressez-vous à la société iGuzzini.
- DE** N.B.: Bezüglich des Austausches der LED kontaktieren Sie bitte die Firma iGuzzini.
- NL** N.B.: Voor het vervangen van de LED neemt u contact op met het bedrijf iGuzzini.
- ES** NOTA: Para sustituir el LED llame a la empresa iGuzzini.
- DA** N.B.: For udskiftning af lysdioden, skal man kontakte iGuzzini.
- NO** N.B.: For informasjon om skifte av LED, vennligst ta kontakt med iGuzzini.
- SV** OBS! För byte av lysdioden, kontakta företaget iGuzzini.
- RU** ПРИМЕЧАНИЕ: Для замены СИДов обращайтесь в компанию iGuzzini.
- ZH** 注意: 如需LED更换的信息, 请联系iGuzzini
- AR** تكتيبه: لاستبدال الضوء LED اتصل بشركة iGuzzini

ART.	corrente assorbita absorbed current courant absorbé Stromaufnahme stromaufnahme corrente absorbida absorberet strøm absorbirt strom absorbered strøm поглощаемая мощность 電源電流 التيار الممتص	fattore di potenza power factor facteur de puissance Leistungsfaktor vermogenfactor factor de potencia effektfaktor effektfaktor effektfaktor faktor мощности 功率因数 عمل القدرة
QF49 - QF50 - QG17 - QG18 - QV75 - QV76 - R496 - R497 - RM26 RL56 - RL86 - RL96 - PQ06 - PQ11 - PQ15 - PQ17 - PQ20 - PQ22	0,06	0,8
QF51 - QF52 - QF53 - QG19 - QG20 - QG21 - QV77 - QV78 - QV79 - R498 R499 - R500 - RM27 - RL58 - RL80 - RL87 - RL97 - PQ07 - PQ10 - PQ12 PQ16 - PQ18 - PQ19 - PQ21 - PQ23 - PW60 - PW61 - PW62	0,06	>0,9
RI78 - RI79 - RM53 - PR89 - PR92 - PR94	0,071	>0,9
RI80 - RI81 - RI82 - RI83 - RM54 - PR90 - PR91 - PR93 - PR95 - PR96	0,078	>0,9
QF54 - QF55 - QG22 - QG23 - QF80 - QF81 - QV80 - QV82 - QW07 - QW09 R758 - R501 - R503 - RM00 - RM10 - RM28 - RL60 - RL70 - RL88 - RI34 RI36 - RI38 - RM40 - PQ24 - PQ30 - PQ34 - PQ38 - PQ42 - PQ48 - PQ52 PQ66 - PQ72 - PQ76 - PR47 - PR53 - PR57 - PR59	0,08	0,87
QF56 - QF57 - QF58 - QG24 - QG25 - QG26 - QF82 - QF83 - QF84 - QF85 - QV84 QV86 - QV88 - QW11 - QW13 - QW15 - QW17 - R760 - R505 - R507 - R509 - RM01 RM02 - RM12 - RM30 - RL62 - RL72 - RL90 - RI40 - RI42 - RI44 - RI46 - RM42 - PQ26 PQ28 - PQ31 - PQ32 - PQ36 - PQ40 - PQ44 - PQ45 - PQ50 - PQ54 - PQ56 - PQ68 PQ70 - PQ74 - PQ78 - PR49 - PR51 - PR55 - PR61 - PR63 - PW63 - PW64 - PW65	0,08	>0,95
QF59 - QF60 - QG27 - QG28 - QF86 - QF87 - QV81 - QV83 - QW08 - QW10 R759 - R502 - R504 - RM11 - RM29 - RL61 - RL71 - RL89 - RI35 - RI37 - RI39 RM41 - PQ25 - PQ35 - PQ39 - PQ43 - PQ49 - PQ53 - PQ67 - PQ73 PQ77 - PR48 - PR54 - PR58 - PR60	0,11	>0,9
QF61 - QF62 - QF63 - QF69 - QF70 - QF71 - QF88 - QF89 - QF90 - QF91 - QF98 QF99 - QG01 - QG02 - QG29 - QG30 - QG31 - QG34 - QG35 - QG36 - QV85 QV87 - QV89 - QV97 - QV99 - QW01 - QW12 - QW14 - QW16 - QW18 - QW27 QW29 - QW31 - QW33 - R761 - R506 - R508 - R510 - RM03 - RM07 - RM13 RM17 - RM31 - RM34 - RM43 - RM47 - RL63 - RL73 - RL91 - R764 - R515 - R517 R519 - RL67 - RL77 - RL94 - RI41 - RI43 - RI45 - RI47 - RI57 - RI59 - RI61 - RI63 PQ27 - PQ29 - PQ33 - PQ37 - PQ41 - PQ46 - PQ47 - PQ51 - PQ55 - PQ57 - PQ69 PQ71 - PQ75 - PQ79 - PQ82 - PQ84 - PQ88 - PQ92 - PQ96 - PR00 - PR02 - PR06 PR10 - PR12 - PR24 - PR26 - PR30 - PR34 - PR50 - PR52 - PR56 - PR62 - PR64 PR73 - PR75 - PR79 - PR85 - PR87 - PW66 - PW67 - PW68 - PW72 - PW73	0,11	>0,95
QF67 - QF68 - QG32 - QG33 - QF97 - QF99 - QV93 - QV95 - QW23 - QW25 R762 - R511 - R513 - RM05 - RM15 - RM32 - RM45 - RL65 - RL75 - RL92 - RI51 RI53 RI55 - PQ80 - PQ86 - PQ90 - PQ94 - PQ98 - PR04 - PR08 - PR22 - PR28 PR32 - PR71 - PR77 - PR81 - PR83	0,12	>0,9
QF72 - QF73 - QG03 - QG04 - QG37 - QG38 - QF74 - QF75 - QF76 - QG39 - QG40 QG41 - QV94 - QV96 - QW00 - QW03 - QW24 - QW26 - QV96 - R763 - R765 R512 - R514 - R516 - R518 - R520 - RM03 - RM06 - RM08 - RM16 - RM33 - RM35 RL66 - RL68 - RL76 - RL93 - RL95 - PQ81 - PQ83 - PQ85 - PQ87 - PQ89 - PQ91 PQ93 - PQ95 - PQ97 - PQ99 - PR05 - PR09 - PR23 - PR25 - PR27 - PR29 - PR31 PR33 - PR35 - PW74 - PW75	0,16	>0,95
RI52 - RI54 - RI56 - RM46 - PR72 - PR78 - PR82 - PR84	0,141	>0,9
RI58 - RI60 - RI62 - RI64 - RM48 - PR74 - PR76 - PR80 - PR86 - PR88	0,142	>0,95
QG05 - QG06 - QG07 - QG08 - QW28 - QW30 - QW32 - QW34 RL78 - RM18 - PR01 - PR03 - PR07 - PR11 - PR13	0,15	>0,95
QG13 - QG14	0,32	-
QG15 - QG16	0,49	-
R521 - R522 - RL98 - RL99 - RI29 - RI32 - RM38 - RM39 - PQ08 PQ09 - PQ13 - PQ14 - PR37 - PR39 - PR43 - PR44	0,04	>0,9
R448 - R449 - R450 - R451 - R452 - R453 - RL81 - RI68 - RI69 - RI70 RI71 - RI72 - RI73 - RM50 - RM51 - PR65 - PR66 - PR67 - PR68 PR69 - PR70 - PS29 - PS30 - PV69 - PW70 - PW71	0,043	>0,9
R460 - R461 - R462 - R463 - RL84 - PW76 - PW77	0,085	>0,9
R468 - R469 - R470 - R471 - R472 - R473 - RM20 - RM21 - RI27 - RI28 - RI30 RI31 - RI33 - RM36 - RM37 - PQ58 - PQ59 - PQ60 - PQ61 - PQ62 - PQ63 PQ64 - PQ65 - PR36 - PR38 - PR40 - PR41 - PR42 - PR45 - PR46	0,05	>0,9
R478 - R479 - RM23 - PR14 - PR17 - PR19	0,095	>0,9
R458 - R459 - R480 - R481 - R482 - R483 - RM24 RL83 - PR15 - PR16 - PR18 - PR20 - PR21	0,09	>0,9

**IT** ATTENZIONE: con questo errore di collegamento il prodotto rischia di bloccarsi (FIG. 1). Per ripristinare, premere il pulsante 5 volte in 3 secondi come in FIG. 2, dopo che il difetto è stato rimosso.

**EN** WARNING: with this connection error the product risks to get blocked (FIG. 1). To restore, press the button 5 times in 3 seconds as shown in FIG. 2 after removing the defect.

**FR** ATTENTION : cette erreur de raccordement risque de bloquer le produit (FIG. 1). Pour rétablir son fonctionnement, appuyer sur le bouton 5 fois de suite pendant 3 secondes comme illustré FIG. 2, après avoir supprimé le défaut.

**DE** ACHTUNG: Bei diesem Anschlussfehler kann sich das Produkt blockieren (ABB. 1). Zum Zurücksetzen drücken Sie die Taste 5 Mal innerhalb von 3 Sekunden wie in ABB. 2 gezeigt, nachdem der Fehler behoben wurde.

**NL** OPGELET: met deze aansluitingsstoring riskeert u dat het product blokkeert. (AFB. 1). Om dit te herstellen moet u 5 keer in 3 seconden op de toets drukken, zoals aangegeven in AFB. 2, nadat de storing is opgelost.

**ES** ATENCIÓN: con este error de conexión existe un riesgo de bloqueo del producto (FIG. 1). Para restablecer, oprimir el pulsador 5 veces en 3 segundos según ilustrado en la FIG. 2, después de eliminar el defecto.

**DA** ADVARSEL: med denne koblingsfeilen risikerer produktet å blokkeres (FIG. 1). For å gjenopprette, trykk på knappen 5 ganger i løpet av 3 sekunder, som angitt i FIG. 2, etter at feilen er fjernet.

**NO** PAS PÅ: Ved den type feil i forbindelsen kan man risikere, at produktet låses fast (FIG. 1). For at genoprette funktionen skal man trykke knappen ind 5 gange i 3 sekunder, som vist i FIG. 2, efter at fejlen er blevet udbedret.

**SV** OBSERVERA! Med detta fel finns det risk för att produkten blockeras (FIG. 1). För att återställa efter att defekten har åtgärdats, tryck ned knappen 5 gånger i 3 sekunder som i FIG. 2

**RU** ВНИМАНИЕ: при наличии этой ошибки соединения продукт может заблокироваться (РИС. 1). Для восстановления нажмите на кнопку 5 раз за 3 секунды, как указано на РИС. 2, после того как был устранен дефект.

**ZH** 注意：出现这种故障时，灯具可能停止运行（1号图表）。要重新启动，排除故障之后，请按照2号图表按按钮五次，每次三秒钟。

**AR** تنبيه: خطر حدوث عطل مع هذا الخطأ في التوصيل. (الشكل 1) لإعادة التشغيل اضغط على الزر 5 مرات في 3 ثوان كما هو موضح في الشكل 2، بعد التأكد من تلاشي الخطأ.

FIG. 1

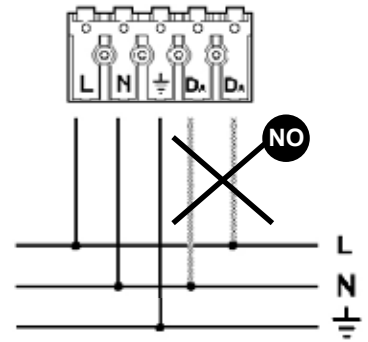
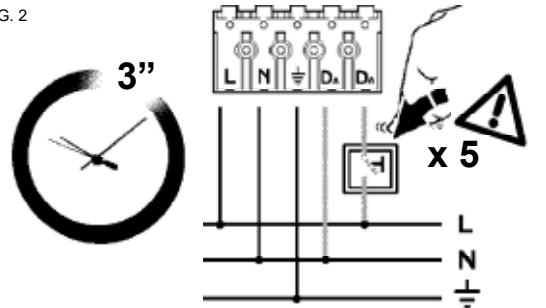

FIG. 2



1.154.681.11 IS13563/17	<b>iCuzini</b>	corrente assorbita absorbed current courant absorbé Stromaufnahme stromoegname corrente absorbida absorberet stram absorbirt stram tilford ström поглощаемая мощность 电源电流 التيار الممتص	fattore di potenza power factor facteur de puissance Leistungsfaktor vermogensfactor factor de potencia effektfaktor effektfaktor effektfaktor faktor мощности 功率因数 عمل القدرة
<b>ART.</b>			
QF49 - QF50 - QG17 - QG18 - QV75 - QV76 - R496 - R497 - RM26 RL56 - RL86 - RL96 - PQ06 - PQ11 - PQ15 - PQ17 - PQ20 - PQ22		0,06	0,8
QF51 - QF52 - QF53 - QG19 - QG20 - QG21 - QV77 - QV78 - QV79 - R498 R499 - R500 - RM27 - RL58 - RL80 - RL87 - RL97 - PQ07 - PQ10 - PQ12 PQ16 - PQ18 - PQ19 - PQ21 - PQ23 - PW60 - PW61 - PW62		0,06	>0,9
RI78 - RI79 - RM53 - PR89 - PR92 - PR94		0,071	>0,9
RI80 - RI81 - RI82 - RI83 - RM54 - PR90 - PR91 - PR93 - PR95 - PR96		0,078	>0,9
QF54 - QF55 - QG22 - QG23 - QF80 - QF81 - QV80 - QV82 - QW07 - QW09 R758 - R501 - R503 - RM00 - RM10 - RM28 - RL60 - RL70 - RL88 - RI34 RI36 - RI38 - RM40 - PQ24 - PQ30 - PQ34 - PQ38 - PQ42 - PQ48 - PQ52 PQ66 - PQ72 - PQ76 - PR47 - PR53 - PR57 - PR59		0,08	0,87
QF56 - QF57 - QF58 - QG24 - QG25 - QG26 - QF82 - QF83 - QF84 - QF85 - QV84 QV86 - QV88 - QW11 - QW13 - QW15 - QW17 - R760 - R505 - R507 - R509 - RM01 RM02 - RM12 - RM30 - RL62 - RL72 - RL90 - R140 - R142 - R144 - R146 - RM42 - PQ26 PQ28 - PQ31 - PQ32 - PQ36 - PQ40 - PQ44 - PQ45 - PQ50 - PQ54 - PQ56 - PQ68 PQ70 - PQ74 - PQ78 - PR49 - PR51 - PR55 - PR61 - PR63 - PW63 - PW64 - PW65		0,08	>0,95
QF59 - QF80 - QG27 - QG28 - QF86 - QF87 - QV81 - QV83 - QW08 - QW10 R759 - R502 - R504 - RM11 - RM29 - RL61 - RL71 - RL89 - RI35 - RI37 - RI39 RM41 - PQ25 - PQ35 - PQ39 - PQ43 - PQ49 - PQ53 - PQ67 - PQ73 PQ77 - PR48 - PR54 - PR58 - PR60		0,11	>0,9
QF61 - QF62 - QF63 - QF69 - QF70 - QF71 - QF88 - QF89 - QF90 - QF91 - QF98 QF99 - QG01 - QG02 - QG29 - QG30 - QG31 - QG34 - QG35 - QG36 - QV85 QV87 - QV89 - QV97 - QV99 - QW01 - QW12 - QW14 - QW16 - QW18 - QW27 QW29 - QW31 - QW33 - R761 - R506 - R508 - R510 - RM03 - RM07 - RM13 RM17 - RM31 - RM34 - RM43 - RM47 - RL63 - RL73 - RL91 - R764 - R515 - R517 R519 - RL67 - RL77 - RL94 - RI41 - RI43 - RI45 - RI47 - RI57 - RI59 - RI61 - RI63 PQ27 - PQ29 - PQ33 - PQ37 - PQ41 - PQ46 - PQ47 - PQ51 - PQ55 - PQ57 - PQ69 PQ71 - PQ75 - PQ79 - PQ82 - PQ84 - PQ88 - PQ92 - PQ96 - PR00 - PR02 - PR06 PR10 - PR12 - PR24 - PR26 - PR30 - PR34 - PR50 - PR52 - PR56 - PR62 - PR64 PR73 - PR75 - PR79 - PR85 - PR87 - PW66 - PW67 - PW68 - PW72 - PW73		0,11	>0,95
QF67 - QF68 - QG32 - QG33 - QF96 - QF97 - QV93 - QV95 - QW23 - QW25 R762 - R511 - R513 - RM05 - RM15 - RM32 - RM45 - RL65 - RL75 - RL92 - RI51 RI53 - RI55 - PQ80 - PQ86 - PQ90 - PQ94 - PQ98 - PR04 - PR08 - PR22 - PR28 PR32 - PR71 - PR77 - PR81 - PR83		0,12	>0,9
QF72 - QF73 - QG03 - QG04 - QG37 - QG38 - QF74 - QF75 - QF76 - QG39 - QG40 QG41 - QV94 - QV96 - QW00 - QW03 - QW24 - QW26 - QV98 - R763 - R765 R512 - R514 - R516 - R518 - R520 - RM03 - RM06 - RM08 - RM16 - RM33 - RM35 RL66 - RL68 - RL76 - RL93 - RL95 - PQ81 - PQ83 - PQ85 - PQ87 - PQ89 - PQ91 PQ93 - PQ95 - PQ97 - PQ99 - PR05 - PR09 - PR23 - PR25 - PR27 - PR29 - PR31 PR33 - PR35 - PW74 - PW75		0,16	>0,95
RI52 - RI54 - RI56 - RM46 - PR72 - PR78 - PR82 - PR84		0,141	>0,9
RI58 - RI60 - RI62 - RI64 - RM48 - PR74 - PR76 - PR80 - PR86 - PR88		0,142	>0,95
QG05 - QG06 - QG07 - QG08 - QW28 - QW30 - QW32 - QW34 RL78 - RM18 - PR01 - PR03 - PR07 - PR11 - PR13		0,15	>0,95
QG13 - QG14		0,32	-
QG15 - QG16		0,49	-
R521 - R522 - RL98 - RL99 - RI29 - RI32 - RM38 - RM39 - PQ08 PQ09 - PQ13 - PQ14 - PR37 - PR39 - PR43 - PR44		0,04	>0,9
R448 - R449 - R450 - R451 - R452 - R453 - RL81 - RI68 - RI69 - RI70 RI71 - RI72 - RI73 - RM50 - RM51 - PR65 - PR66 - PR67 - PR68 PR69 - PR70 - PS29 - PS30 - PW69 - PW70 - PW71		0,043	>0,9
R460 - R461 - R462 - R463 - RL84 - PW76 - PW77		0,085	>0,9
R468 - R469 - R470 - R471 - R472 - R473 - RM20 - RM21 - RI27 - RI28 - RI30 RI31 - RI33 - RM36 - RM37 - PQ58 - PQ59 - PQ60 - PQ61 - PQ62 - PQ63 PQ64 - PQ65 - PR36 - PR38 - PR40 - PR41 - PR42 - PR45 - PR46		0,05	>0,9
R478 - R479 - RM23 - PR14 - PR17 - PR19		0,095	>0,9
R458 - R459 - R480 - R481 - R482 - R483 - RM24 RL83 - PR15 - PR16 - PR18 - PR20 - PR21		0,09	>0,9

1.154.681.11 IS13563/17	<b>iCuzini</b>	corrente assorbita absorbed current courant absorbé Stromaufnahme stromoegname corrente absorbida absorberet stram absorbirt stram tilford ström поглощаемая мощность 电源电流 التيار الممتص	fattore di potenza power factor facteur de puissance Leistungsfaktor vermogensfactor factor de potencia effektfaktor effektfaktor effektfaktor faktor мощности 功率因数 عمل القدرة
<b>ART.</b>			
QF49 - QF50 - QG17 - QG18 - QV75 - QV76 - R496 - R497 - RM26 RL56 - RL86 - RL96 - PQ06 - PQ11 - PQ15 - PQ17 - PQ20 - PQ22		0,06	0,8
QF51 - QF52 - QF53 - QG19 - QG20 - QG21 - QV77 - QV78 - QV79 - R498 R499 - R500 - RM27 - RL58 - RL80 - RL87 - RL97 - PQ07 - PQ10 - PQ12 PQ16 - PQ18 - PQ19 - PQ21 - PQ23 - PW60 - PW61 - PW62		0,06	>0,9
RI78 - RI79 - RM53 - PR89 - PR92 - PR94		0,071	>0,9
RI80 - RI81 - RI82 - RI83 - RM54 - PR90 - PR91 - PR93 - PR95 - PR96		0,078	>0,9
QF54 - QF55 - QG22 - QG23 - QF80 - QF81 - QV80 - QV82 - QW07 - QW09 R758 - R501 - R503 - RM00 - RM10 - RM28 - RL60 - RL70 - RL88 - RI34 RI36 - RI38 - RM40 - PQ24 - PQ30 - PQ34 - PQ38 - PQ42 - PQ48 - PQ52 PQ66 - PQ72 - PQ76 - PR47 - PR53 - PR57 - PR59		0,08	0,87
QF56 - QF57 - QF58 - QG24 - QG25 - QG26 - QF82 - QF83 - QF84 - QF85 - QV84 QV86 - QV88 - QW11 - QW13 - QW15 - QW17 - R760 - R505 - R507 - R509 - RM01 RM02 - RM12 - RM30 - RL62 - RL72 - RL90 - R140 - R142 - R144 - R146 - RM42 - PQ26 PQ28 - PQ31 - PQ32 - PQ36 - PQ40 - PQ44 - PQ45 - PQ50 - PQ54 - PQ56 - PQ68 PQ70 - PQ74 - PQ78 - PR49 - PR51 - PR55 - PR61 - PR63 - PW63 - PW64 - PW65		0,08	>0,95
QF59 - QF80 - QG27 - QG28 - QF86 - QF87 - QV81 - QV83 - QW08 - QW10 R759 - R502 - R504 - RM11 - RM29 - RL61 - RL71 - RL89 - RI35 - RI37 - RI39 RM41 - PQ25 - PQ35 - PQ39 - PQ43 - PQ49 - PQ53 - PQ67 - PQ73 PQ77 - PR48 - PR54 - PR58 - PR60		0,11	>0,9
QF61 - QF62 - QF63 - QF69 - QF70 - QF71 - QF88 - QF89 - QF90 - QF91 - QF98 QF99 - QG01 - QG02 - QG29 - QG30 - QG31 - QG34 - QG35 - QG36 - QV85 QV87 - QV89 - QV97 - QV99 - QW01 - QW12 - QW14 - QW16 - QW18 - QW27 QW29 - QW31 - QW33 - R761 - R506 - R508 - R510 - RM03 - RM07 - RM13 RM17 - RM31 - RM34 - RM43 - RM47 - RL63 - RL73 - RL91 - R764 - R515 - R517 R519 - RL67 - RL77 - RL94 - RI41 - RI43 - RI45 - RI47 - RI57 - RI59 - RI61 - RI63 PQ27 - PQ29 - PQ33 - PQ37 - PQ41 - PQ46 - PQ47 - PQ51 - PQ55 - PQ57 - PQ69 PQ71 - PQ75 - PQ79 - PQ82 - PQ84 - PQ88 - PQ92 - PQ96 - PR00 - PR02 - PR06 PR10 - PR12 - PR24 - PR26 - PR30 - PR34 - PR50 - PR52 - PR56 - PR62 - PR64 PR73 - PR75 - PR79 - PR85 - PR87 - PW66 - PW67 - PW68 - PW72 - PW73		0,11	>0,95
QF67 - QF68 - QG32 - QG33 - QF96 - QF97 - QV93 - QV95 - QW23 - QW25 R762 - R511 - R513 - RM05 - RM15 - RM32 - RM45 - RL65 - RL75 - RL92 - RI51 RI53 - RI55 - PQ80 - PQ86 - PQ90 - PQ94 - PQ98 - PR04 - PR08 - PR22 - PR28 PR32 - PR71 - PR77 - PR81 - PR83		0,12	>0,9
QF72 - QF73 - QG03 - QG04 - QG37 - QG38 - QF74 - QF75 - QF76 - QG39 - QG40 QG41 - QV94 - QV96 - QW00 - QW03 - QW24 - QW26 - QV98 - R763 - R765 R512 - R514 - R516 - R518 - R520 - RM03 - RM06 - RM08 - RM16 - RM33 - RM35 RL66 - RL68 - RL76 - RL93 - RL95 - PQ81 - PQ83 - PQ85 - PQ87 - PQ89 - PQ91 PQ93 - PQ95 - PQ97 - PQ99 - PR05 - PR09 - PR23 - PR25 - PR27 - PR29 - PR31 PR33 - PR35 - PW74 - PW75		0,16	>0,95
RI52 - RI54 - RI56 - RM46 - PR72 - PR78 - PR82 - PR84		0,141	>0,9
RI58 - RI60 - RI62 - RI64 - RM48 - PR74 - PR76 - PR80 - PR86 - PR88		0,142	>0,95
QG05 - QG06 - QG07 - QG08 - QW28 - QW30 - QW32 - QW34 RL78 - RM18 - PR01 - PR03 - PR07 - PR11 - PR13		0,15	>0,95
QG13 - QG14		0,32	-
QG15 - QG16		0,49	-
R521 - R522 - RL98 - RL99 - RI29 - RI32 - RM38 - RM39 - PQ08 PQ09 - PQ13 - PQ14 - PR37 - PR39 - PR43 - PR44		0,04	>0,9
R448 - R449 - R450 - R451 - R452 - R453 - RL81 - RI68 - RI69 - RI70 RI71 - RI72 - RI73 - RM50 - RM51 - PR65 - PR66 - PR67 - PR68 PR69 - PR70 - PS29 - PS30 - PW69 - PW70 - PW71		0,043	>0,9
R460 - R461 - R462 - R463 - RL84 - PW76 - PW77		0,085	>0,9
R468 - R469 - R470 - R471 - R472 - R473 - RM20 - RM21 - RI27 - RI28 - RI30 RI31 - RI33 - RM36 - RM37 - PQ58 - PQ59 - PQ60 - PQ61 - PQ62 - PQ63 PQ64 - PQ65 - PR36 - PR38 - PR40 - PR41 - PR42 - PR45 - PR46		0,05	>0,9
R478 - R479 - RM23 - PR14 - PR17 - PR19		0,095	>0,9
R458 - R459 - R480 - R481 - R482 - R483 - RM24 RL83 - PR15 - PR16 - PR18 - PR20 - PR21		0,09	>0,9

1.154.681.11 IS13563/17	<b>iCuzini</b>	corrente assorbita absorbed current courant absorbé Stromaufnahme stromoegname corrente absorbida absorberet stram absorbirt stram tilford ström поглощаемая мощность 电源电流 التيار الممتص	fattore di potenza power factor facteur de puissance Leistungsfaktor vermogensfactor factor de potencia effektfaktor effektfaktor effektfaktor faktor мощности 功率因数 عمل القدرة
<b>ART.</b>			
QF49 - QF50 - QG17 - QG18 - QV75 - QV76 - R496 - R497 - RM26 RL56 - RL86 - RL96 - PQ06 - PQ11 - PQ15 - PQ17 - PQ20 - PQ22		0,06	0,8
QF51 - QF52 - QF53 - QG19 - QG20 - QG21 - QV77 - QV78 - QV79 - R498 R499 - R500 - RM27 - RL58 - RL80 - RL87 - RL97 - PQ07 - PQ10 - PQ12 PQ16 - PQ18 - PQ19 - PQ21 - PQ23 - PW60 - PW61 - PW62		0,06	>0,9
RI78 - RI79 - RM53 - PR89 - PR92 - PR94		0,071	>0,9
RI80 - RI81 - RI82 - RI83 - RM54 - PR90 - PR91 - PR93 - PR95 - PR96		0,078	>0,9
QF54 - QF55 - QG22 - QG23 - QF80 - QF81 - QV80 - QV82 - QW07 - QW09 R758 - R501 - R503 - RM00 - RM10 - RM28 - RL60 - RL70 - RL88 - RI34 RI36 - RI38 - RM40 - PQ24 - PQ30 - PQ34 - PQ38 - PQ42 - PQ48 - PQ52 PQ66 - PQ72 - PQ76 - PR47 - PR53 - PR57 - PR59		0,08	0,87
QF56 - QF57 - QF58 - QG24 - QG25 - QG26 - QF82 - QF83 - QF84 - QF85 - QV84 QV86 - QV88 - QW11 - QW13 - QW15 - QW17 - R760 - R505 - R507 - R509 - RM01 RM02 - RM12 - RM30 - RL62 - RL72 - RL90 - R140 - R142 - R144 - R146 - RM42 - PQ26 PQ28 - PQ31 - PQ32 - PQ36 - PQ40 - PQ44 - PQ45 - PQ50 - PQ54 - PQ56 - PQ68 PQ70 - PQ74 - PQ78 - PR49 - PR51 - PR55 - PR61 - PR63 - PW63 - PW64 - PW65		0,08	>0,95
QF59 - QF80 - QG27 - QG28 - QF86 - QF87 - QV81 - QV83 - QW08 - QW10 R759 - R502 - R504 - RM11 - RM29 - RL61 - RL71 - RL89 - RI35 - RI37 - RI39 RM41 - PQ25 - PQ35 - PQ39 - PQ43 - PQ49 - PQ53 - PQ67 - PQ73 PQ77 - PR48 - PR54 - PR58 - PR60		0,11	>0,9
QF61 - QF62 - QF63 - QF69 - QF70 - QF71 - QF88 - QF89 - QF90 - QF91 - QF98 QF99 - QG01 - QG02 - QG29 - QG30 - QG31 - QG34 - QG35 - QG36 - QV85 QV87 - QV89 - QV97 - QV99 - QW01 - QW12 - QW14 - QW16 - QW18 - QW27 QW29 - QW31 - QW33 - R761 - R506 - R508 - R510 - RM03 - RM07 - RM13 RM17 - RM31 - RM34 - RM43 - RM47 - RL63 - RL73 - RL91 - R764 - R515 - R517 R519 - RL67 - RL77 - RL94 - RI41 - RI43 - RI45 - RI47 - RI57 - RI59 - RI61 - RI63 PQ27 - PQ29 - PQ33 - PQ37 - PQ41 - PQ46 - PQ47 - PQ51 - PQ55 - PQ57 - PQ69 PQ71 - PQ75 - PQ79 - PQ82 - PQ84 - PQ88 - PQ92 - PQ96 - PR00 - PR02 - PR06 PR10 - PR12 - PR24 - PR26 - PR30 - PR34 - PR50 - PR52 - PR56 - PR62 - PR64 PR73 - PR75 - PR79 - PR85 - PR87 - PW66 - PW67 - PW68 - PW72 - PW73		0,11	>0,95
QF67 - QF68 - QG32 - QG33 - QF96 - QF97 - QV93 - QV95 - QW23 - QW25 R762 - R511 - R513 - RM05 - RM15 - RM32 - RM45 - RL65 - RL75 - RL92 - RI51 RI53 - RI55 - PQ80 - PQ86 - PQ90 - PQ94 - PQ98 - PR04 - PR08 - PR22 - PR28 PR32 - PR71 - PR77 - PR81 - PR83		0,12	>0,9
QF72 - QF73 - QG03 - QG04 - QG37 - QG38 - QF74 - QF75 - QF76 - QG39 - QG40 QG41 - QV94 - QV96 - QW00 - QW03 - QW24 - QW26 - QV98 - R763 - R765 R512 - R514 - R516 - R518 - R520 - RM03 - RM06 - RM08 - RM16 - RM33 - RM35 RL66 - RL68 - RL76 - RL93 - RL95 - PQ81 - PQ83 - PQ85 - PQ87 - PQ89 - PQ91 PQ93 - PQ95 - PQ97 - PQ99 - PR05 - PR09 - PR23 - PR25 - PR27 - PR29 - PR31 PR33 - PR35 - PW74 - PW75		0,16	>0,95
RI52 - RI54 - RI56 - RM46 - PR72 - PR78 - PR82 - PR84		0,141	>0,9
RI58 - RI60 - RI62 - RI64 - RM48 - PR74 - PR76 - PR80 - PR86 - PR88		0,142	>0,95
QG05 - QG06 - QG07 - QG08 - QW28 - QW30 - QW32 - QW34 RL78 - RM18 - PR01 - PR03 - PR07 - PR11 - PR13		0,15	>0,95
QG13 - QG14		0,32	-
QG15 - QG16		0,49	-
R521 - R522 - RL98 - RL99 - RI29 - RI32 - RM38 - RM39 - PQ08 PQ09 - PQ13 - PQ14 - PR37 - PR39 - PR43 - PR44		0,04	>0,9
R448 - R449 - R450 - R451 - R452 - R453 - RL81 - RI68 - RI69 - RI70 RI71 - RI72 - RI73 - RM50 - RM51 - PR65 - PR66 - PR67 - PR68 PR69 - PR70 - PS29 - PS30 - PW69 - PW70 - PW71		0,043	>0,9
R460 - R461 - R462 - R463 - RL84 - PW76 - PW77		0,085	>0,9
R468 - R469 - R470 - R471 - R472 - R473 - RM20 - RM21 - RI27 - RI28 - RI30 RI31 - RI33 - RM36 - RM37 - PQ58 - PQ59 - PQ60 - PQ61 - PQ62 - PQ63 PQ64 - PQ65 - PR36 - PR38 - PR40 - PR41 - PR42 - PR45 - PR46		0,05	>0,9
R478 - R479 - RM23 - PR14 - PR17 - PR19		0,095	>0,9
R458 - R459 - R480 - R481 - R482 - R483 - RM24 RL83 - PR15 - PR16 - PR18 - PR20 - PR21		0,09	>0,9





- I Istruzioni per le operazioni di servizio per l'apparecchio di illuminazione**  
**GB Instructions on luminaire service operations**  
**F Instructions pour les opérations de service du luminaire**  
**D Wartungsanleitung für die Leuchte**  
**NL Instructies voor de onderhoudsoperaties op de verlichtingsarmatuur**  
**E Instrucciones para las operaciones de servicio del aparato de alumbrado**  
**DK Anvisninger i serviceindgreb på belysningsarmatur**  
**N Anvisninger for betjening av lysapparatet**  
**S Instruktioner för användning av belysningsanordningen**  
**RUS Инструкции по эксплуатации осветительного прибора**  
**CN 照明装置检修操作说明**

**Sostituire la lampada parzialmente esausta**  
 Replace the partly exhausted lamp  
 Remplacer la lampe partiellement épuisée  
 Die teilweise erschöpfte Lampe austauschen  
 Vervang de gedeeltelijk lege lamp  
 Sustituir la lámpara parzialmente agotada  
 Udskift den delvist udtjente pære  
 Skifte ut den delvis utbrænte lyspæren  
 Byt ut den delvis förbrukade lampan  
 Замена частично отработанной лампочки  
 更换部分老化的灯泡



**Spegnimento**  
 Switch it off  
 Extinction  
 Ausschaltung  
 Uitschakeling  
 Apagado  
 Slukning  
 Slukking  
 Släckning  
 Выключение  
 关灯

**Interrompere l'alimentazione dell'apparecchio**  
 Cut the power supply to the luminaire  
 Couper l'alimentation du luminaire  
 Stromversorgung der Leuchte unterbrechen  
 Onderbreek de voeding van het apparaat  
 Interrumpir la alimentación del aparato  
 Afbryd armaturets strømforsyning  
 Avbryt strømtilførselen til apparatet  
 Koppla från anordningens strömförsörjning  
 Отключить электропитание прибора  
 中断装置供电



**Aprire l'apparecchio**  
 Open the fixture  
 Ouvrir le luminaire  
 Das Gerät öffnen  
 Open het apparaat  
 Abrir el aparato  
 Åbn armaturet  
 Åpne apparatet  
 Öppna anordningen  
 Раскрыть прибор  
 打开装置

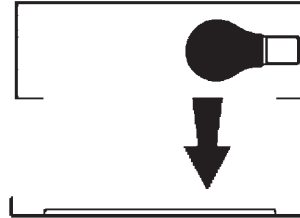

**Rimuovere la lampada esausta**  
 Remove the exhausted lamp  
 Retirer la lampe épuisée  
 Die alte Lampe entnehmen  
 Verwijder de lege lamp  
 Quitar la lámpara agotada  
 Tag den udtjente pære ud  
 Fjerne den utbrænte lyspæren  
 Ta bort den förbrukade lampan  
 Вынуть старую лампочку  
 取出老化的灯泡

**Portarla in un centro di riciclaggio**  
 Carry it to a recycling centre  
 La porter dans une déchetterie pour son recyclage  
 Ordnungsgemäß entsorgen  
 Breng de lamp naar een recyclingcentrum  
 Llevarla a un centro de reciclaje  
 Aflever den på en genbrugsstation  
 Lever den til en miljøstasjon  
 Lämna in den till en återvinningsanläggning  
 Сдать ее в пункт приема утильсырья  
 将其送往回收中心



**Inserire la nuova lampada**  
 Introduce the new lamp  
 Installer la lampe neuve  
 Die neue Lampe einsetzen  
 Doe de nieuwe lamp op zijn plek  
 Montar la nueva lámpara  
 Sæt den nye pære i  
 Sette i den nye pæren  
 Sätt i den nya lampan  
 Вставить новую лампочку  
 装入新灯泡

**Inserire la nuova lampada nel portalampana**  
 Fit the new lamp into the socket  
 Installer la nouvelle lampe dans le support de lampe  
 Die neue Lampe in den Sockel einsetzen  
 Doe de nieuwe lamp in de lamphouder  
 Montar la nueva lámpara en el portalampana  
 Sæt den nye pære i fatningen  
 Sette den nye pæren inn i lampeholderen  
 Sätt i den nya lampan i lamphållaren  
 Вставить новую лампочку в патрон  
 将新灯泡插入灯泡架中



**Riposizionare ottica**  
 Re-place the optic  
 Remettre l'optique à sa place  
 Die Optik wieder einsetzen  
 Doe de optiek weer op zijn plaats  
 Volver a montar la óptica  
 Sæt den optiske enhed på plads  
 Innstille linsen  
 Flytta om optiken  
 Отрегулировать линзы  
 重新定位光头



**Effettuare prova di funzionamento**  
 Perform operative test  
 Procéder à un essai de fonctionnement  
 Eine Funktionsprüfung durchführen  
 Controleer de correcte werking  
 Hacer una prueba de funcionamiento  
 Afprøv funktionen  
 Prøve om den fungerer  
 Utför funktionstest  
 Выполнить проверку исправности работы  
 执行功能测试



- I Istruzioni per la pulizia dell'apparecchio di illuminazione  
 GB Instructions on luminaire cleaning operations  
 F Instructions pour le nettoyage du luminaire  
 D Anweisungen zur Reinigung der Leuchte  
 NL Instructies voor de reiniging van de verlichtingsarmatuur  
 E Instrucciones para limpiar el aparato de alumbrado  
 DK Anvisninger i rengøring af belysningsarmaturet  
 N Anvisninger for rengjøring av lysapparatet  
 S Instruktioner för rengöring av belysningsanordningen  
 RUS Инструкции по чистке осветительного прибора  
 CN 照明装置清洁说明

Pulire l'apparecchio  
 Clean the fixture  
 Nettoyer le luminaire  
 Das Gerät reinigen  
 Reinig het apparaat  
 Limpiar el aparato  
 Rengør armaturet  
 Rengjøre apparatet  
 Rengör anordningen  
 Чистка прибора  
 清洁装置



Spegnimento  
 Switch it off  
 Extinction  
 Ausschaltung  
 Uitschakeling  
 Apagado  
 Slukning  
 Slukking  
 Släckning  
 Выключение  
 关灯

Interrompere l'alimentazione dell'apparecchio  
 Cut the power supply to the luminaire  
 Couper l'alimentation du luminaire  
 Stromversorgung der Leuchte unterbrechen  
 Onderbreek de voeding van het apparaat  
 Interrumpir la alimentación del aparato  
 Afbryd armaturets strømforsyning  
 Avbryt strømtilførselen til apparatet  
 Koppla från anordningens strömförsörjning  
 Отключить электропитание прибора  
 中断装置供电



Spolverare l'ottica esterna  
 Remove dust from the external optic  
 Dépoussiérer l'optique extérieure  
 Die externe Optik abstauben  
 Stof de externe optiek af  
 Quitar el polvo de la óptica exterior  
 Tør støvet af den udvendige optiske enhed  
 Fjerne støv fra den eksterne lysenheden  
 Damma av den yttre optiken  
 Вытереть пыль с внешней стороны линз  
 为外侧镜头掸尘



Lavare l'ottica esterna  
 Wash the external optic  
 Laver l'optique extérieure  
 Die externe Optik waschen  
 Was de externe optiek  
 Lavar la óptica exterior  
 Vask den udvendige optiske enhed  
 Vaske den eksterne lysenheden  
 Rengör den yttre optiken  
 Вымыть линзы с внешней стороны  
 清洁外镜头



Rimuovere l'ottica  
 Remove the optic  
 Retirer l'optique  
 Die Optik abnehmen  
 Verwijder de optiek  
 Quitar la óptica  
 Tag den optiske enhed af  
 Fjerne lysenheden  
 Ta bort optiken  
 Снять линзы  
 取下镜头



Pulire la parte interna dell'apparecchio di illuminazione  
 Clean the inside of the fixture  
 Nettoyer l'intérieur du luminaire  
 Die Innenseite der Leuchte reinigen  
 Reinig de binnenzijde van de verlichtingsarmatuur  
 Limpiar el interior del aparato de alumbrado  
 Rengør belysningsarmaturets indvendige dele  
 Rengjøre lysapparatet innvendig  
 Rengör belysningsanordningen invändigt  
 Протереть осветительный прибор изнутри  
 清洁照明装置内部



Riposizionare ottica  
 Re-place the optic  
 Remettre l'optique à sa place  
 Die Optik wieder einsetzen  
 Doe de optiek weer op zijn plaats  
 Volver a montar la óptica  
 Sæt den optiske enhed på plads  
 Innstille linsen  
 Flytta om optiken  
 Отрегулировать линзы  
 重新定位镜头



Effettuare prova di funzionamento  
 Perform operative test  
 Procéder à un essai de fonctionnement  
 Eine Funktionsprüfung durchführen  
 Controleer de correcte werking  
 Hacer una prueba de funcionamiento  
 Afprøv funktionen  
 Prøve om den fungerer  
 Utför funktionstest  
 Выполнить проверку исправности работы  
 执行功能测试

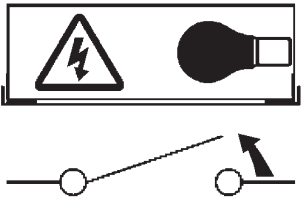
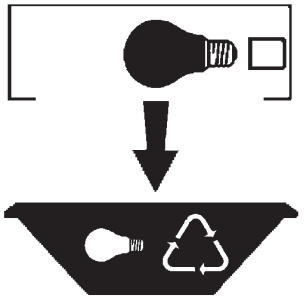
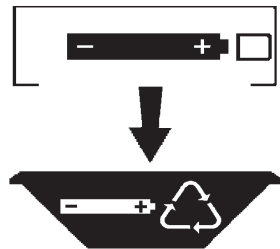
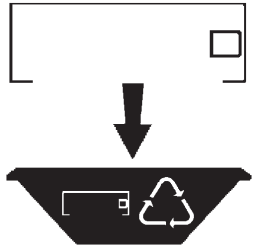

- I Istruzioni per il fine vita e lo smaltimento dei componenti
- GB Instructions on end-of-life and component disposal
- F Instructions pour la gestion des composants en fin de vie et leur mise au rebut
- D Anweisungen zur Entsorgung der Leuchtenkomponenten
- NL Instructies voor het verwijderen van de armatuur en het recyclen van de onderdelen
- E Instrucciones para el final de vida y la eliminación los componentes
- DK Anvisninger i udtjent armatur og bortskaffelse af komponenter
- N Anvisninger for endt levetid og avfallsbehandling av delene
- S Instruktioner vid bortskaffning och kassering av komponenter
- RUS Инструкции по утилизации прибора и его комплектующих по окончании его срока службы
- CN 寿命期结束与零件废弃处置说明

<p>Spegnimento Switch it off Extinction Ausschaltung Uitschakeling Apagado Slukning Slukking Släckning Выключение 关灯</p> <p>Interrompere l'alimentazione dell'apparecchio Cut the power supply to the luminaire Couper l'alimentation du luminaire Stromversorgung der Leuchte unterbrechen Onderbreek de voeding van het apparaat Interrompirla alimentación del aparato Afbryd armaturets strømforsyning Avbryt strømtilførselen til apparatet Koppla från anordningens strömförsörjning Отключить электропитание прибора 中断装置供电</p> 	<p>Rimuovere la/e lampada/e per la dismissione Remove the lamp(s) for decommissioning Retirer la(les) lampe(s) pour sa(leur) mise au rebut Die Lampe/n ordnungsgemäß entsorgen Verwijder de lamp(en) voor het recyclen Quitar la(s) lámpara(s) para el desecho Tag pæren/pærerne ud til bortskaffelse Fjerne lampen/-e som skal kastes Ta bort lampan/-orna för bortskaffningen Вынуть лампочку/и для утилизации прибора 取出需要丢弃的灯泡</p> 	<p>Rimuovere la batteria per la dismissione Remove the battery for decommissioning Retirer la batterie pour sa mise au rebut Die Batterie ordnungsgemäß entsorgen Verwijder de batterij voor het recyclen Quitar la batería para el desecho Tag batteriet ud til bortskaffelse Fjerne batteriet som skal kastes Ta bort batteriet för bortskaffningen Вынуть батарейку для утилизации прибора 取出需要丢弃的电池</p> 	<p>Rimuovere l'apparecchio per la dismissione Remove the fixture for decommissioning Enlever le luminaire pour sa mise au rebut Das Gerät ordnungsgemäß entsorgen Verwijder het apparaat voor het recyclen Quitar el aparato para el desecho Tag armaturet ud til bortskaffelse Fjerne apparatet som skal kastes Ta bort anordningen för bortskaffningen Снять прибор для утилизации 取出需要丢弃的装置</p> 
---	--	--	--

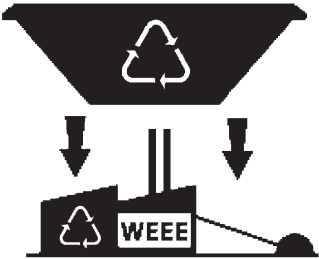
<p>Inviare i materiali ad un centro di raccolta RAEE Send the materials to a WEEE collection centre Envoyer les matériaux dans une déchetterie DEEE Die Materialien in einem WEEE-Zentrum entsorgen Zend de materialen naar een recyclingscentrum voor de AEEA Enviar los materiales a un centro de recogida RAEE Aflever materialerne på et indsamlingscenter for elektronisk udstyr Sende materialene til en miljøstasjon for resirkulering av EE-avfall Skicka materialet till en RAEE uppsamlingscentral Сдать материалы в пункт приема утильсырья 将材料送往电气和电子垃圾回收中心</p> 			
--	--	--	--